

USER'S GUIDE

ALS Cardiac Training Model

BT-ACTB



BT Inc.

BEST TECHNOLOGY & BETTER TOMORROW

Index

1. Cautions	1
2. Product Composition	
2-1 Components	2
2-2 How to store the product	3
2-3 Assemble/Disassemble the legs	4
2-4 Connect manikin	5
2-5 How to insert and replace battery	6
3. Function	
3-1 Function description	7
3-2 Function description – Detailed	8
4. Checking O/S Specification	
4-1 O/S specification	9
5. Checking H/W Spefication	
5-1 H/W specification	10
6. Install Application	
6-1 Developer settings	11
6-2 Install app package file	12~13
7. Start Application	
7-1 Application settings	14
7-2 Connct Facilitator and Monitor	15~16
7-3 Connect Facilitator and Manikin	17~18

8. Facilitator Feature

8-1 Manual mode	19
8-2 Top menu	20
8-3 Bottom menu	21
8-4 Left menu	22
8-5 Right menu	23
8-6 Patient monitor settings	24
8-7 Patient monitor (Graph monitor)	25
8-8 Patient monitor (Numeric monitor)	26
8-9 Patient status viewer	27
8-10 Change the patient status	28
8-11 Scenario mode	29~36
8-12 Library	37
8-13 Result viewer	38~41

9. Monitor Feature

9-1 Patient monitor	42
9-2 Top menu	43
9-3 Bottom menu	44
9-4 Patient monitor settings	45
9-5 Patient monitor (Graph monitor)	46
9-6 Patient monitor (Numeric monitor)	47
9-7 Patient records	48
9-8 NIBP	49
9-9 Medications	50
9-10 Defibrillator	51
9-11 Pacer	52
9-12 Oxygen therapy	53
9-13 Patient status records	54

1. Cautions

Please read this carefully to ensure correct usage and user's safety through understanding of the product.

BT Inc. is not responsible for any accidents occurred by not following the precautions.

- ① Use only components provided or approved by BT Inc.
- ② Do not use the product for any purposes other than described in the manual.
- ③ If you disassemble or modify the product without any permission by BT inc, the warranty will be void. Also, making imitated or altered products for commercial purposes are prohibited by law.
- ④ If the product is overheating or emits a burning odor during usage, turn off the power switch, unplug the power adaptor and call the customer service center.
- ⑤ Please do not install any other S/W on the dedicated laptop. It may occur errors during the training.
- ⑥ Keep the product away from water and moisture area.
- ⑦ Do not use the product near strong magnetic fields or high voltage power lines.
- ⑧ Do not use the product and unplug the power adapter during lightning storms. It can cause malfunction of the product and increase the risk of an electric shock.
- ⑨ The product may malfunction under the extreme weather conditions.
(Operation temperature : 0°C~40°C (32°F~104°F), Storage temperature : -10°C~50°C (14°F~122°F))
- ⑩ Do not keep the product near hot or cold environments as possible. Deterioration of product or internal damage may occur from extreme weather conditions.
- ⑪ Never clean the product with chemicals such as solvent, benzene or thinner as these may cause fire ignition or software malfunction. If you did, please wipe off it gently with a soft cloth immediately.
- ⑫ BT Inc. can change or adjust the product specification without any notice in order to improve the product.

2. Product Composition

2-1. Components

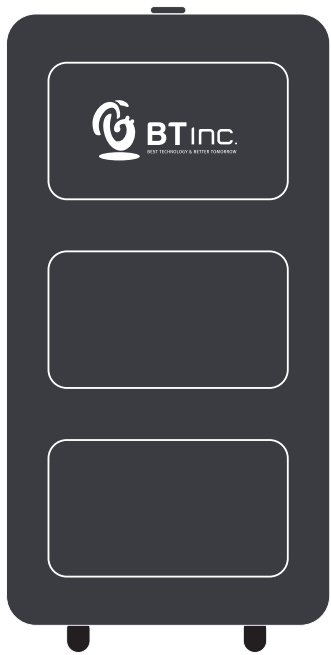

Storage case

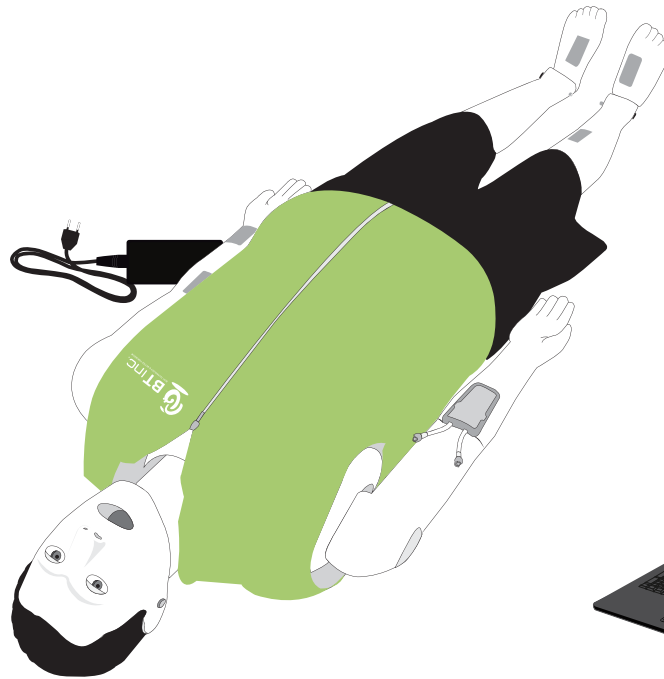

Full body manikin
+ Power adaptor

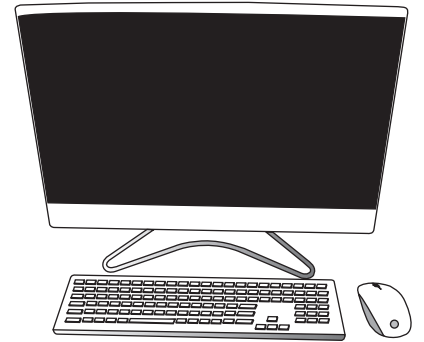

All-in-one PC
for Monitor



Laptop
for Facilitator

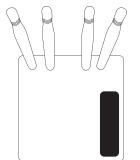

Wifi router



Defibrillation electrode
cover for pads



Defibrillation electrode
cover for leadwires

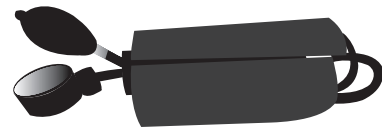

Sphygmomanometer

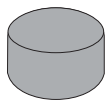

IO/IM module(humerus)

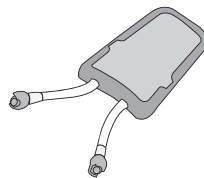

IV pad

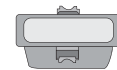

IO module(tibia)

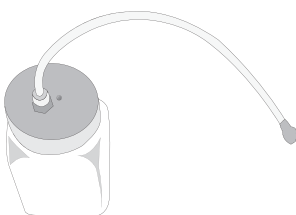

Bottle&tube for IO

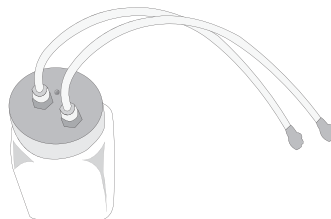

Bottle&tube for IV

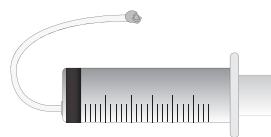

Syringe
for cleaning



Simulated
blood

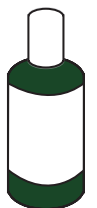

Lubricant

2-2. How to store the product

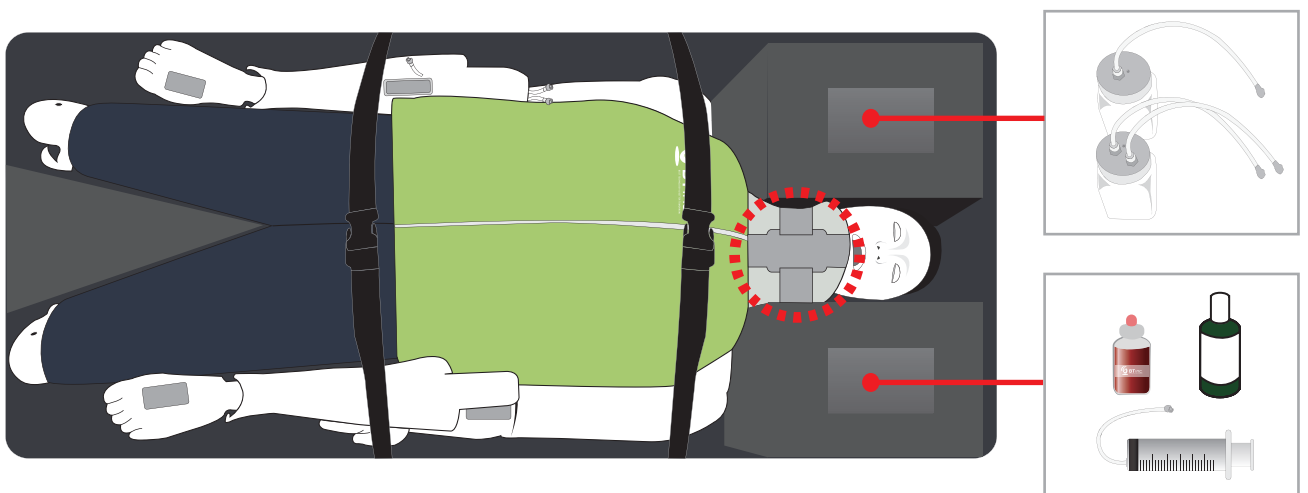
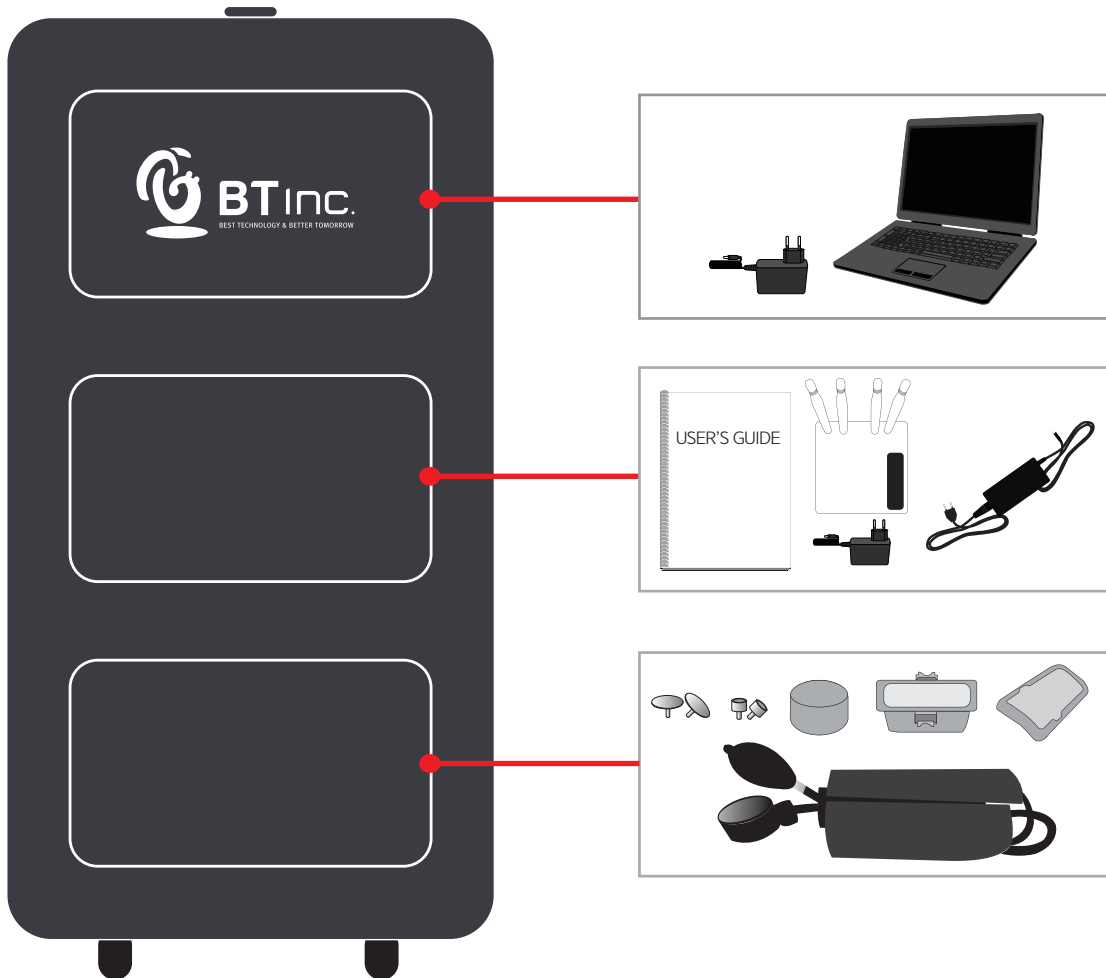

※ Make sure to wear a neck protector on the manikin during storage or transportation.

2-3. Assemble/Disassemble the legs

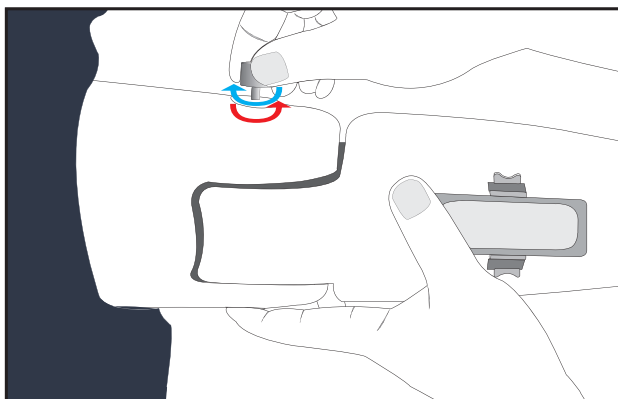
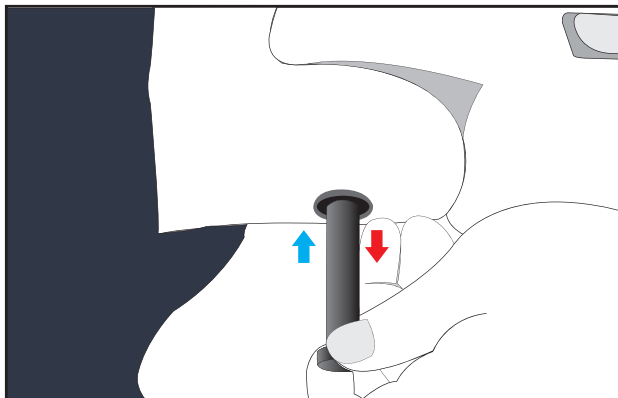
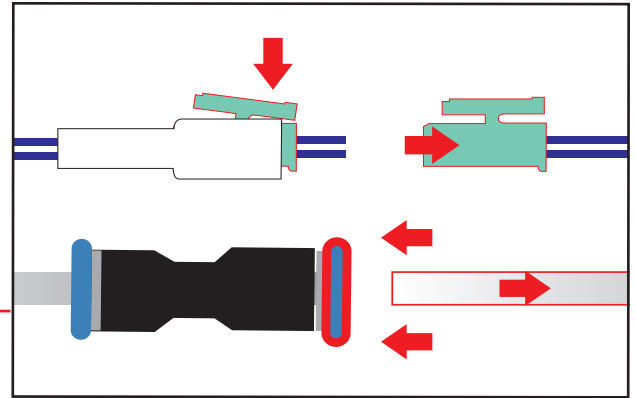
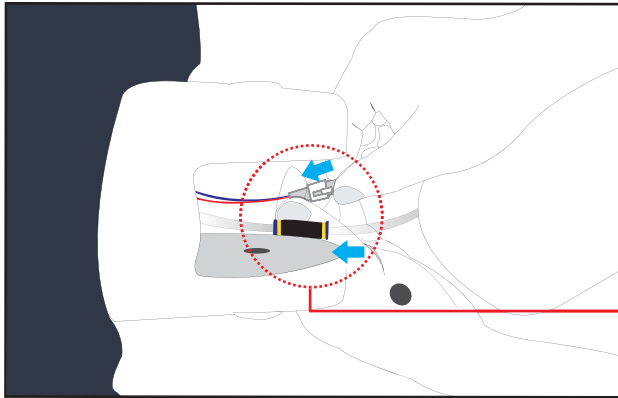

Assemble



Disassemble

※ Disassembly is the reverse order of assembly.

2-4. Connect manikin

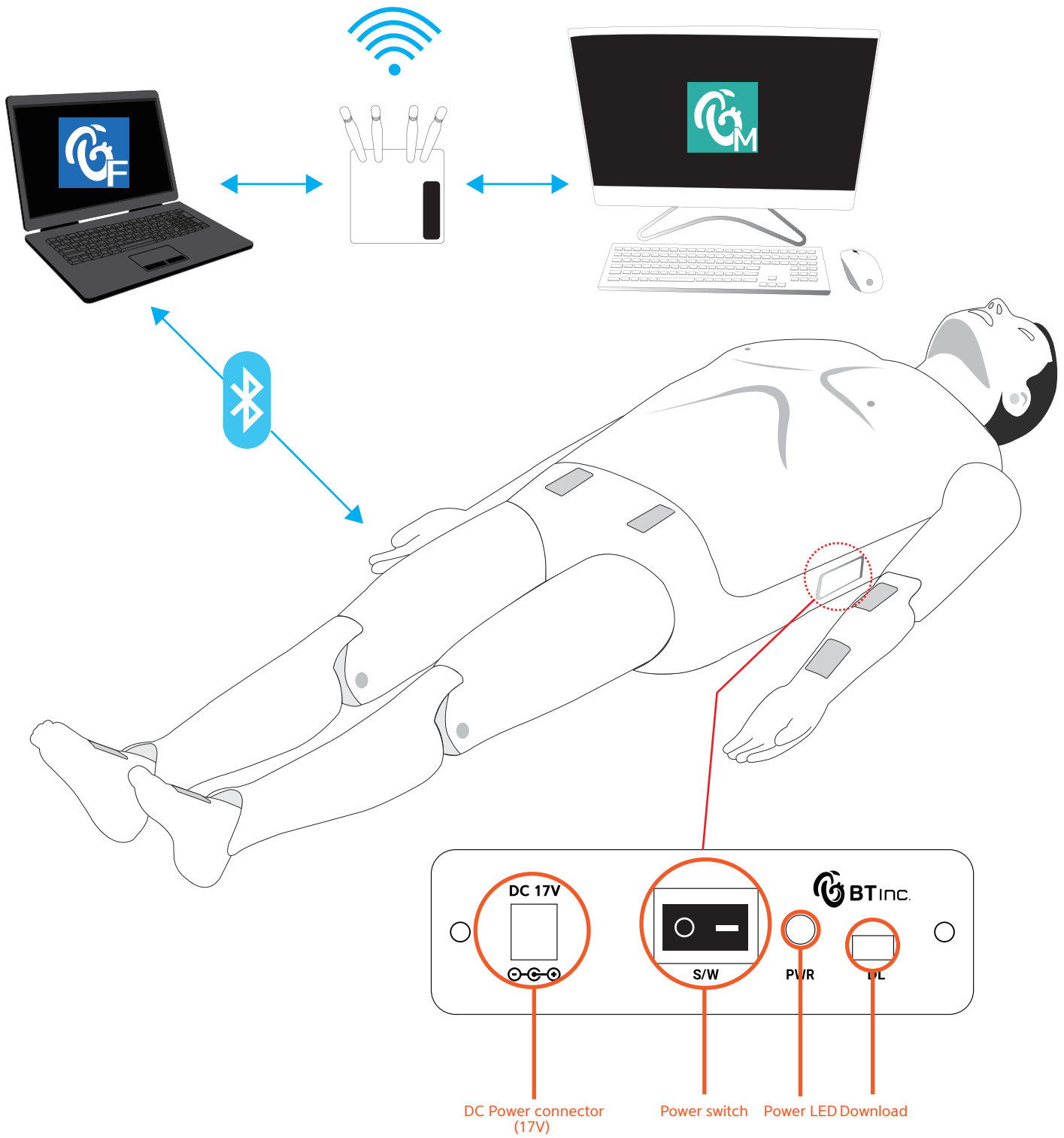

2-5. How to insert and replace battery

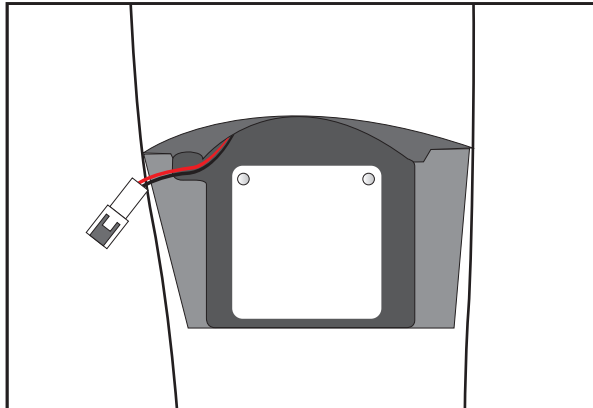

1. Open the battery cover.

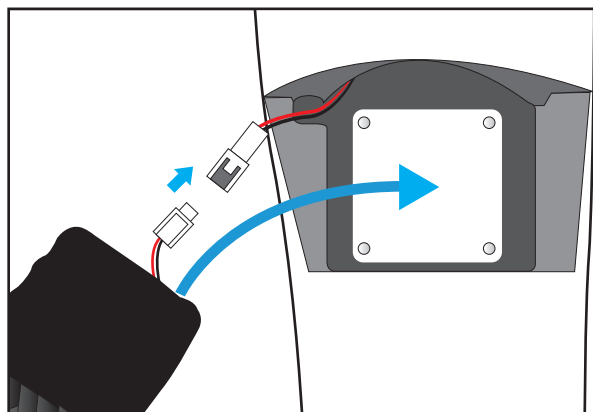

2. Connect the connectors and insert the battery into the manikin.

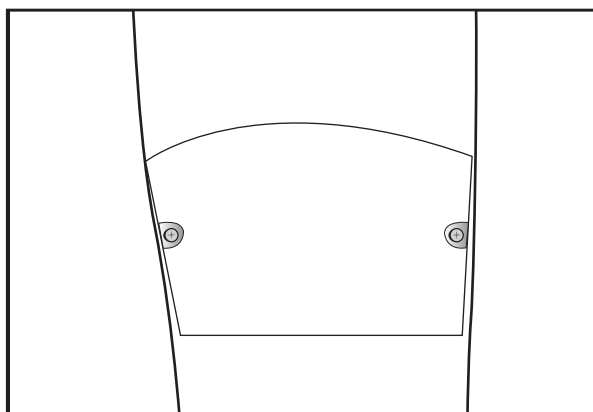

3. Close the battery cover.

※ The battery is located on the right thigh.

3. Functions

3-1. Functions description

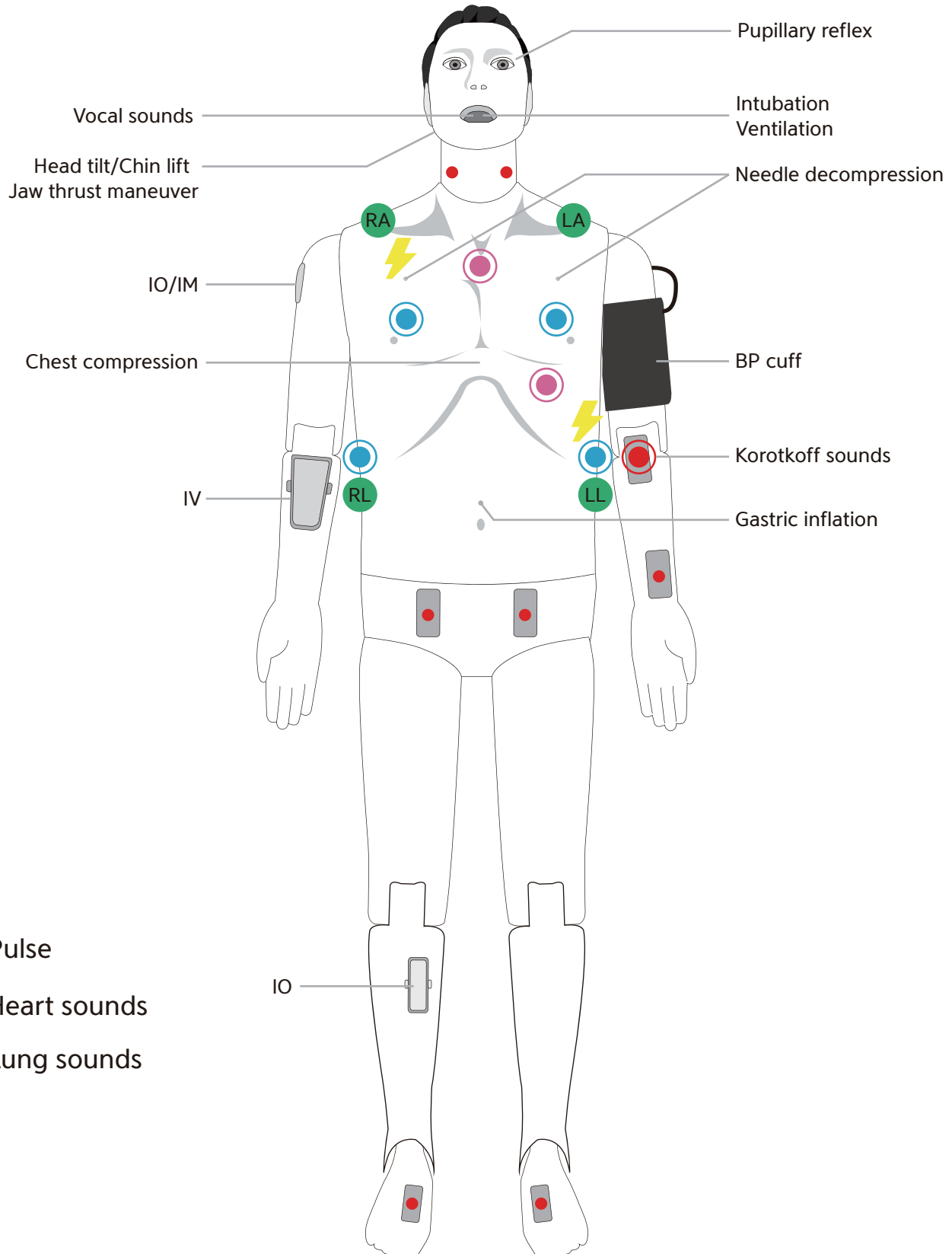

3-2. Function description – Detailed

🟡 Eyes

- ① Light reflex / Consensual light reflex
- ② Adjust pupil size
 - 1~8 mm
- ③ Adjust light reflex speed
 - Prompt / Slow
- ④ Eyelids : Open / Closed

🟡 Airway management

- ① Head tilt / Chin lift
- ② Jaw thrust
- ③ Bag-Valve-Mask ventilation
- ④ Oral / Nasal intubation
 - ETT / LMA / I-gel / Combi-tube
 - Detect Normal / Right mainstem intubation
- ⑤ Detect esophagus Intubation and gastric inflation
- ⑥ Measure force on incisors
- ⑦ Airway obstruction
- ⑧ Needle decompression

🟡 Circulation

- ① 3-4 Lead ECG
- ② Defibrillation and cardioversion
 - Defibrillation waveform
 - CPR waveform
- ③ Heart sounds auscultation (2 sites)
 - Aortic valve / Mitral valve
- ④ Pulse
 - Pulse sites
 - : Radial / Brachial artery (Left arm)
 - : Left / Right carotid artery
 - : Left / Right femoral artery
 - : Left / Right dorsalis artery
 - Pulse intensity
 - : Strong / Moderate / Weak
- ⑤ NIBP
 - Palpation
 - Auscultation
- ⑥ ABP waveform (Software)
- ⑦ PAP waveform (Software)

🟡 Breathing

- ① Spontaneous breathing
 - Unilateral and bilateral chest rise
 - Normal breathing sound
- ② Lung sounds auscultation (4 sites)
 - Chest Front Left Up / Down
 - Chest Front Right Up / Down
- ③ SPO2 waveform (Software)
- ④ ETCO2 waveform (Software)

🟡 CPR

- ① Chest compression
 - Compression depth
 - Hands placement
(Correct/Upper/Lower/Left/Right)
 - Compression rate
 - Incomplete recoil
 - Hands-off time
- ② Artificial respiration
 - Ventilation volume
 - Inspiratory time
 - Ventilation per minute

🟡 Vascular access

- ① IV (Right arm)
- ② IO (Right tibia / Right humerus)
- ③ IM (Right humerus)
- ④ Medication (Software)

🟡 Speech

- ① Vocal sounds
 - 10 cases

4. Checking O/S Specification

4-1. O/S specification

Minimum System requirements : **Windows 10, Version 1809 or later**

- ① Search **winver** at the search box next to windows start menu icon.

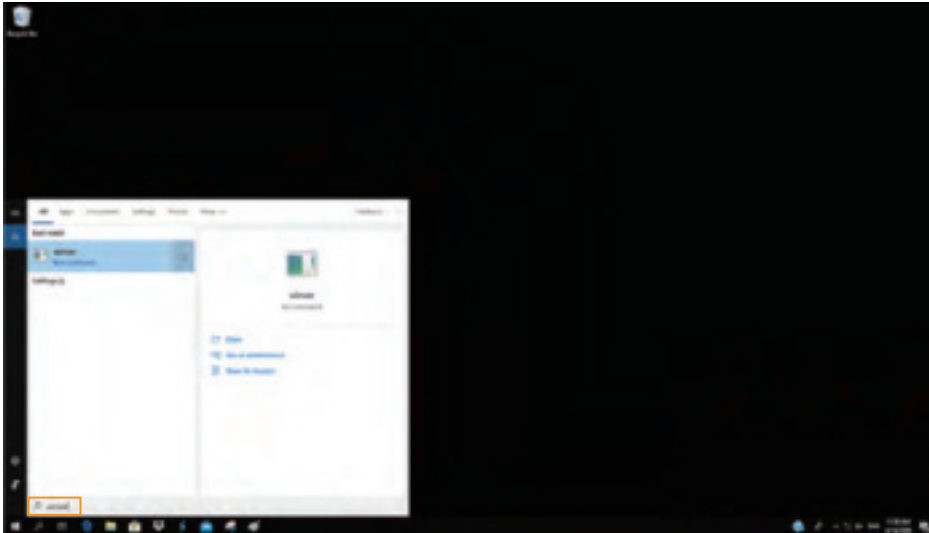

- ② Window version can be checked at the pop-up screen.



5. Checking H/W Spefication

5-1. H/W specification

- Resolution : 1920 X 1080
- Text Size : 100%

① Search **Display settings** at the search box next to windows start menu icon.

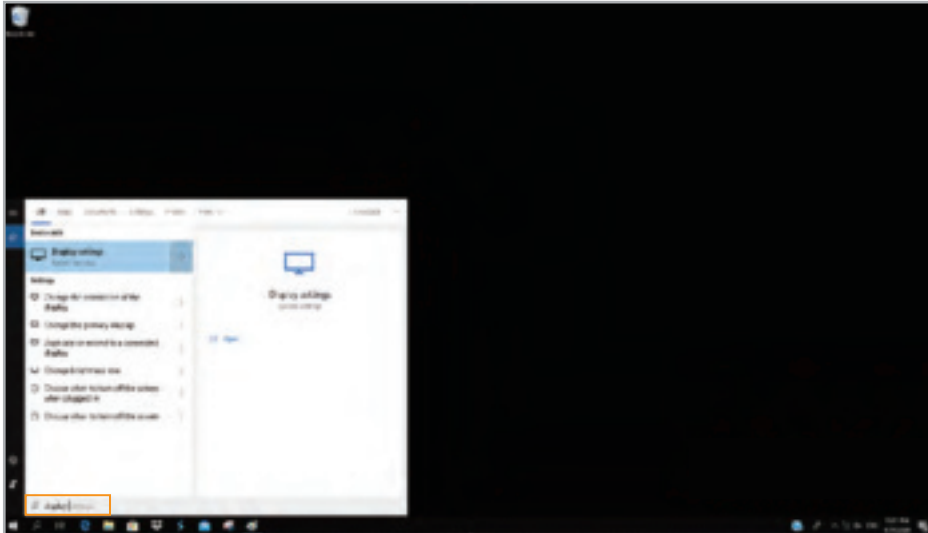

② Set the **Change the size of text** and **Resolution** as below.

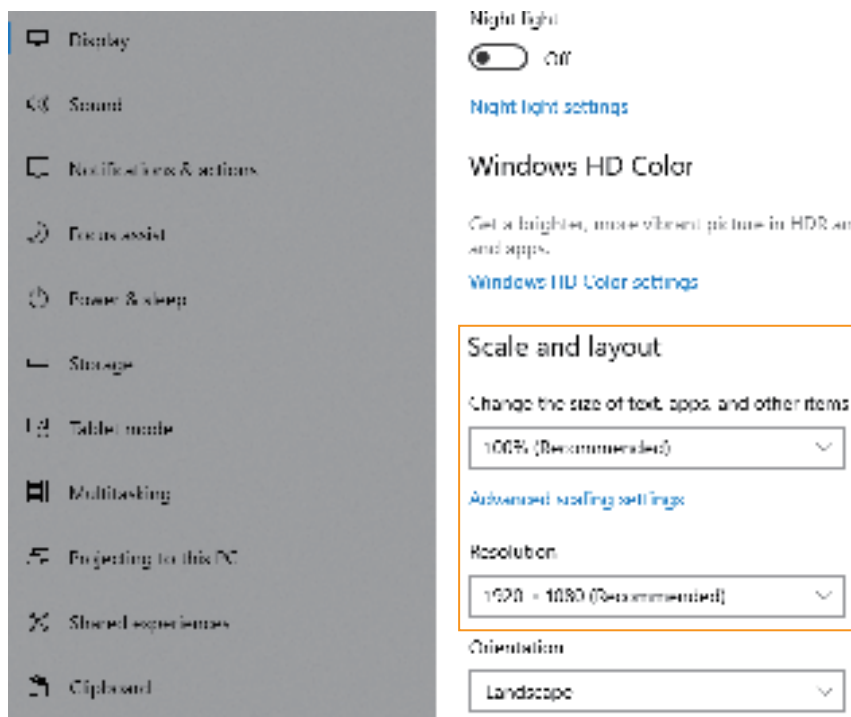

6-2. Install app package file

- ① Select the app package file and right-click to launch **PowerShell**.

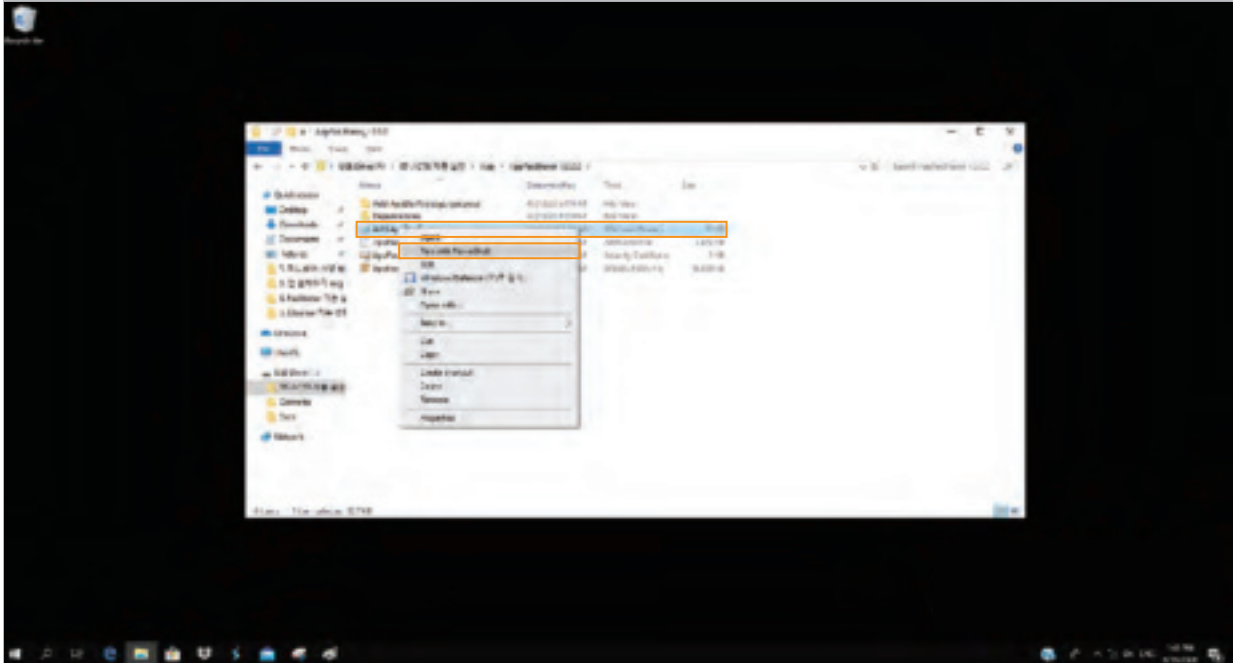

- ② Install the app by following instructions.
 - It may take some time depending on the PC's specification.

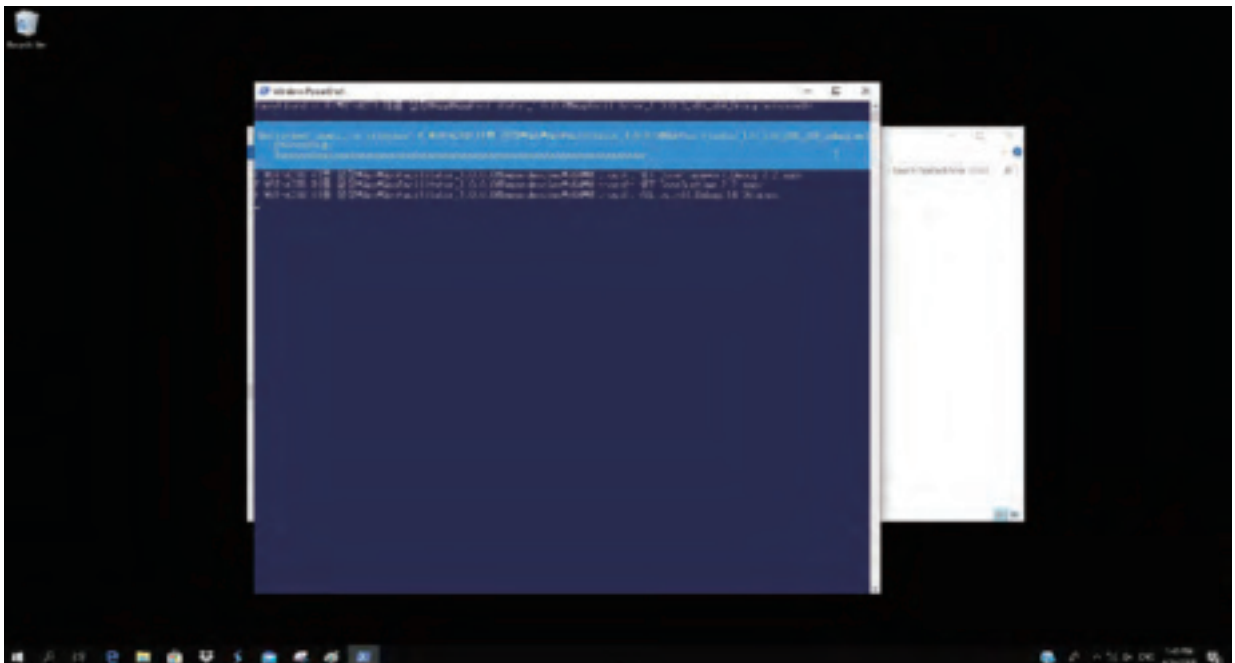

③ When the installation is completed, the app will be on the **windows start menu**.

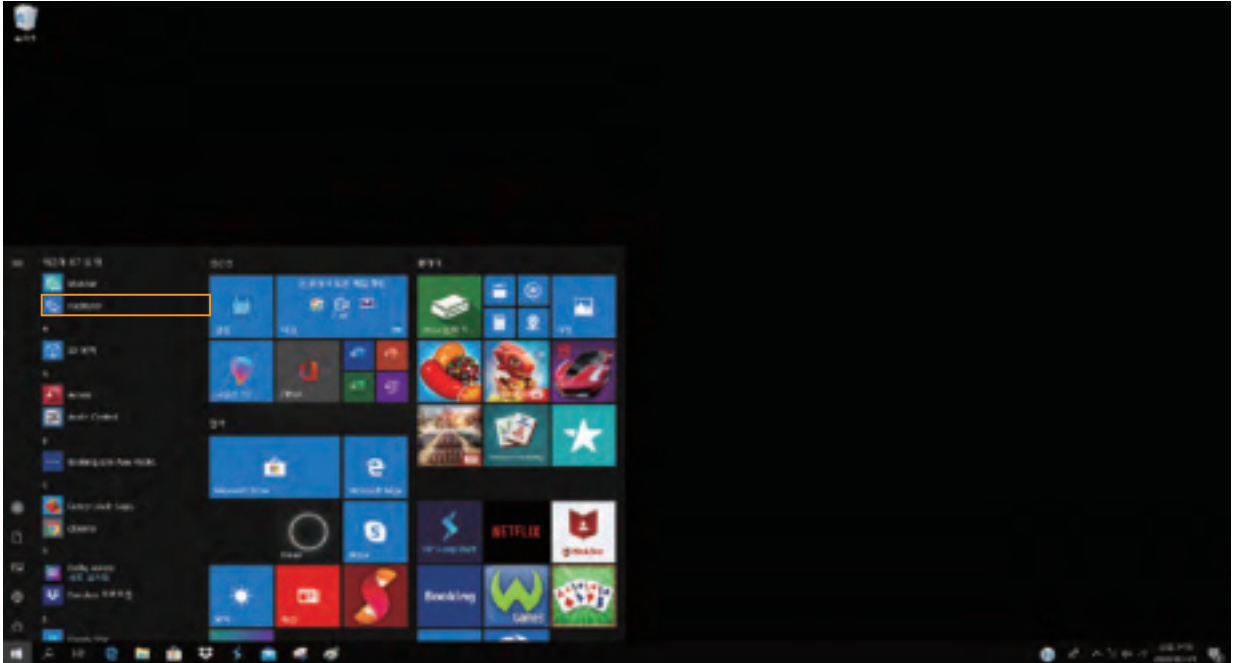

④ The app can be moved to the desktop screen by dragging the mouse.

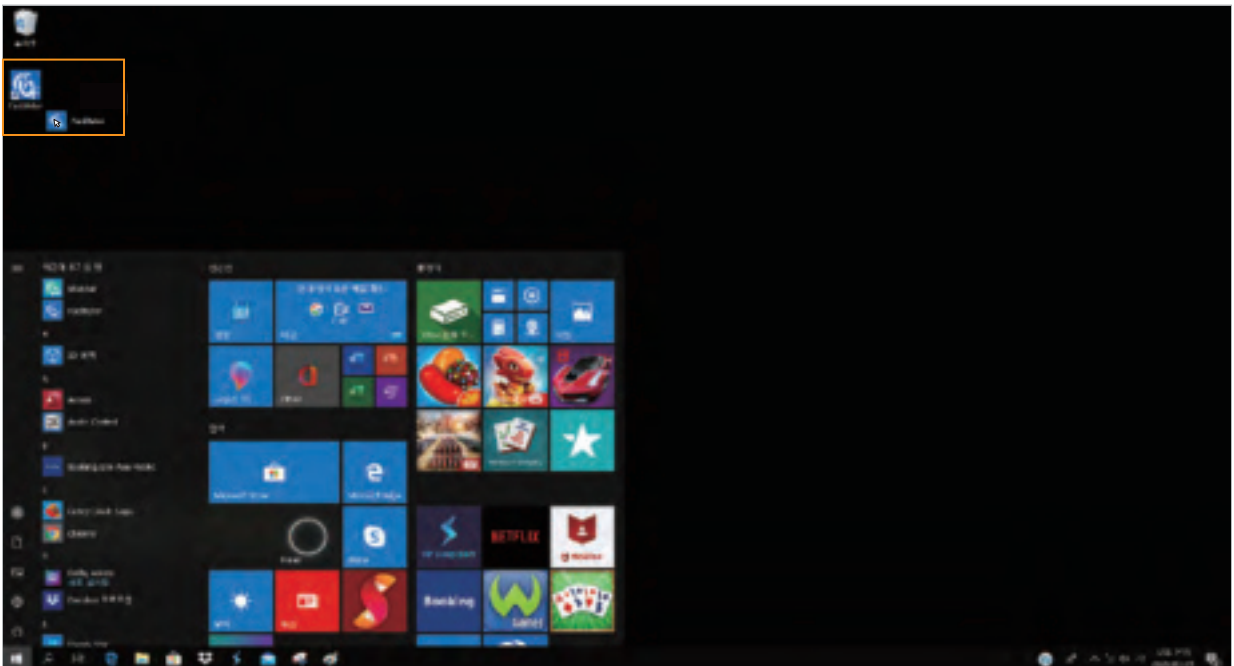

7. Start Application

7-1. Application settings

- ① Start the app and select **Preferences menu** at the left side.

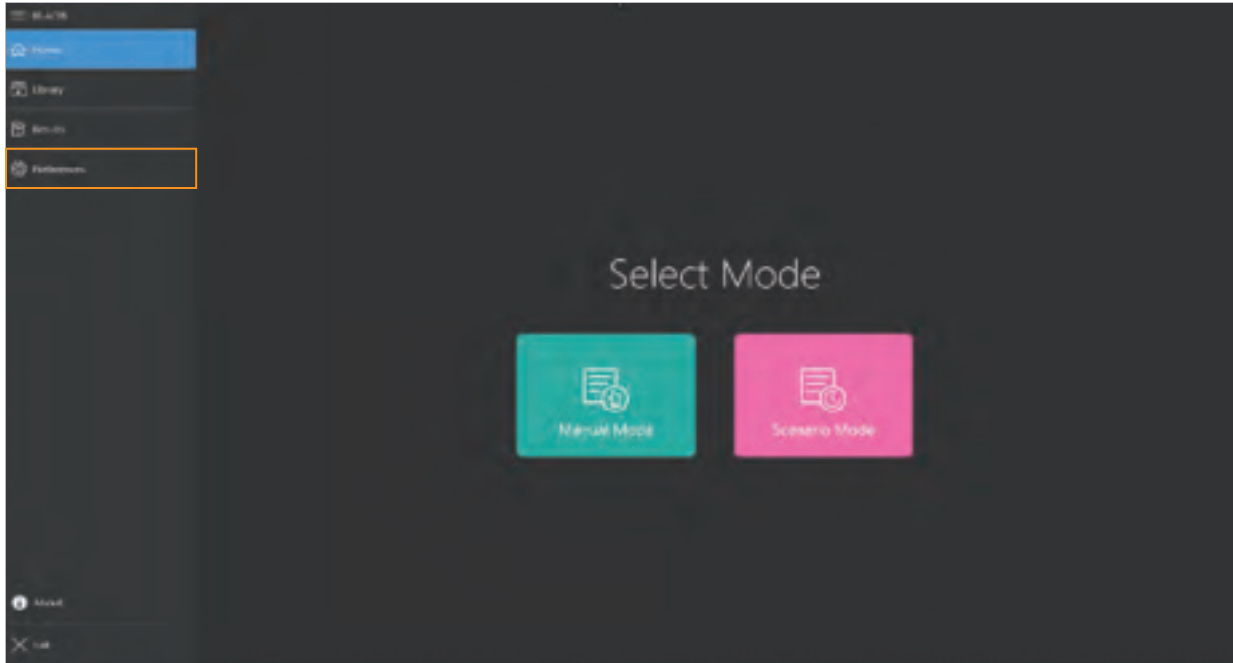

< Home screen >

- ② Select the file system from the **App permissions** at the right side of the screen.

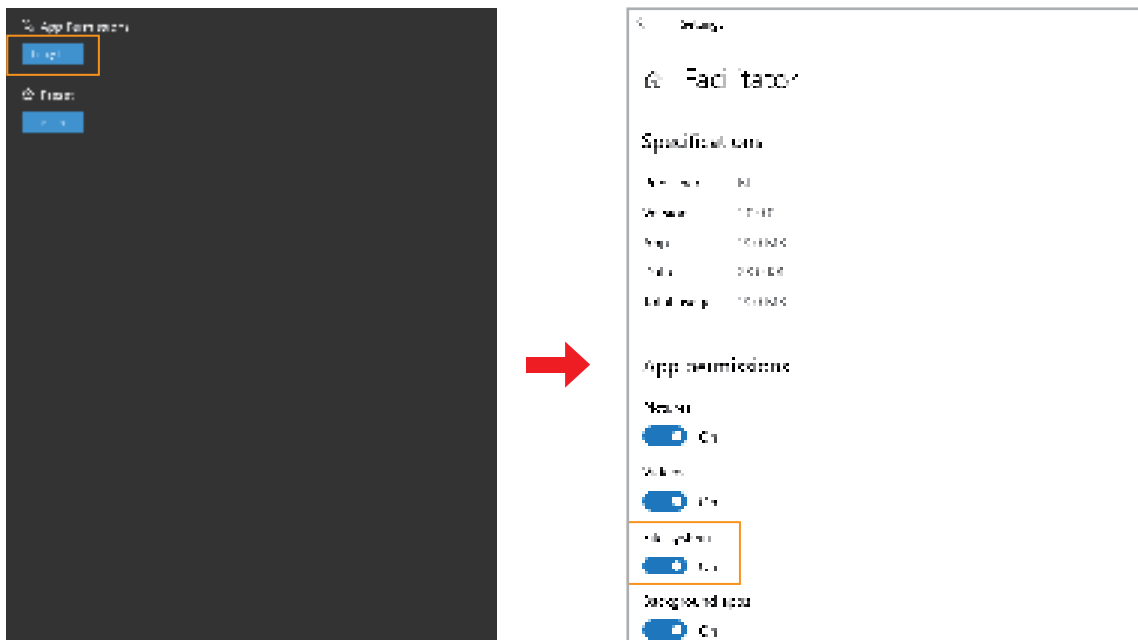

- ③ Activate the file system at the app permissions screen.
- ④ The apps will be automatically shut down when the setting is completed.

7-2. Connct Facilitator and Monitor

① Connect Wi-Fi

- Connect **Facilitator** and **Monitor** to the offered Wi-Fi router.

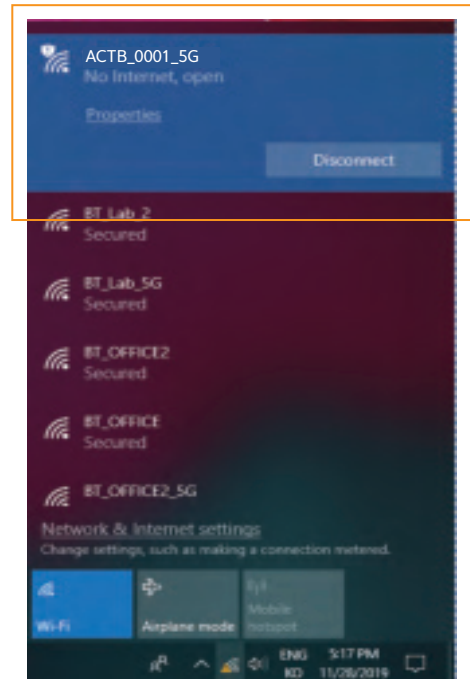
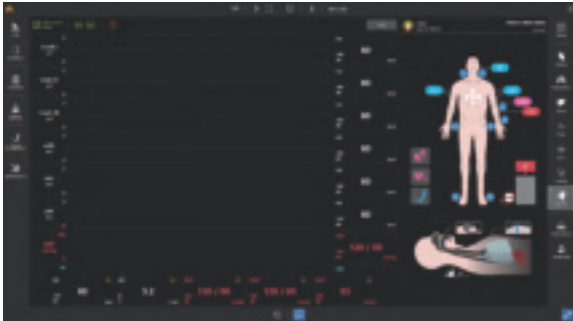

② Facilitator Settings

- Click the **Start button** at the top menu.



③ Monitor Settings

– Click the **Wi-Fi button** at the top menu.

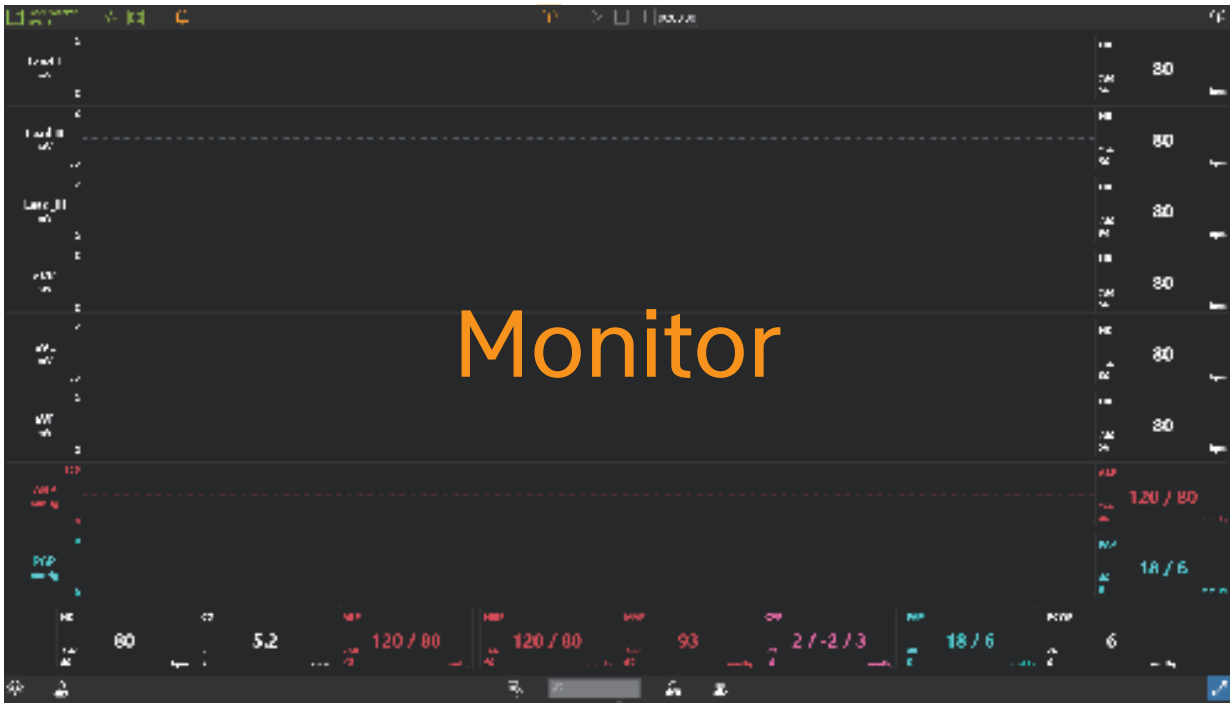

④ When the two apps are connected, you can see the message as shown below.

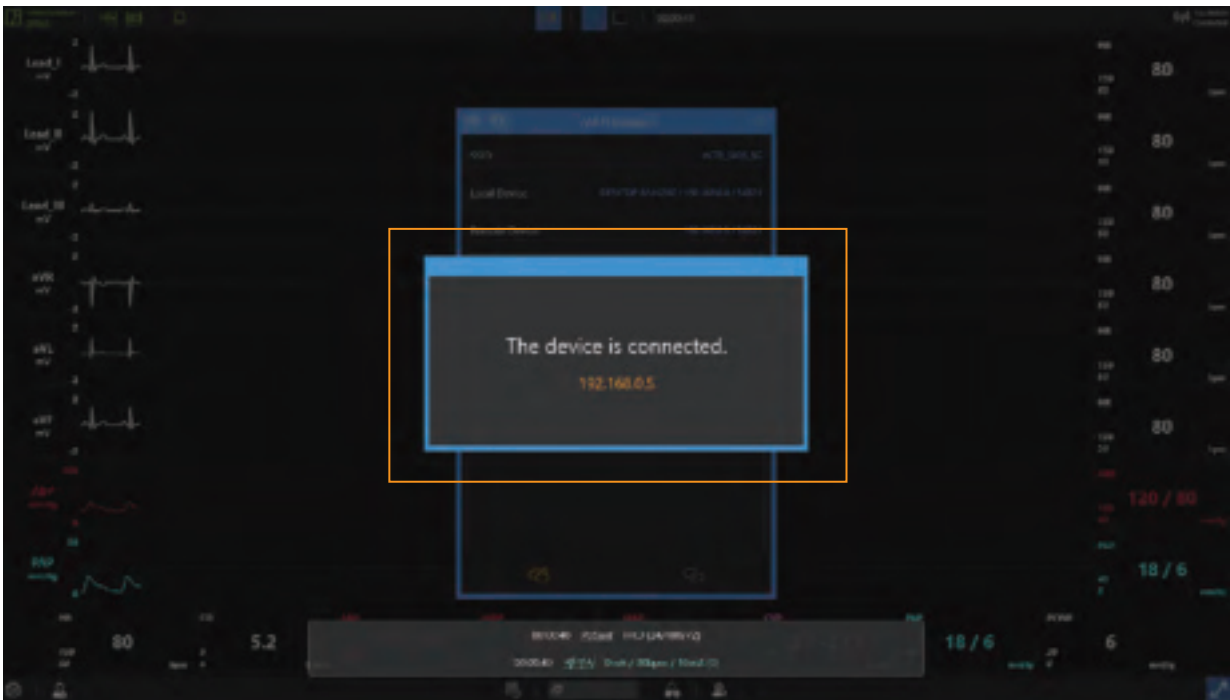

7-3. Connect Facilitator and Manikin

- ① Turn on the manikin.
- ② Click the **Bluetooth button** at the top menu.

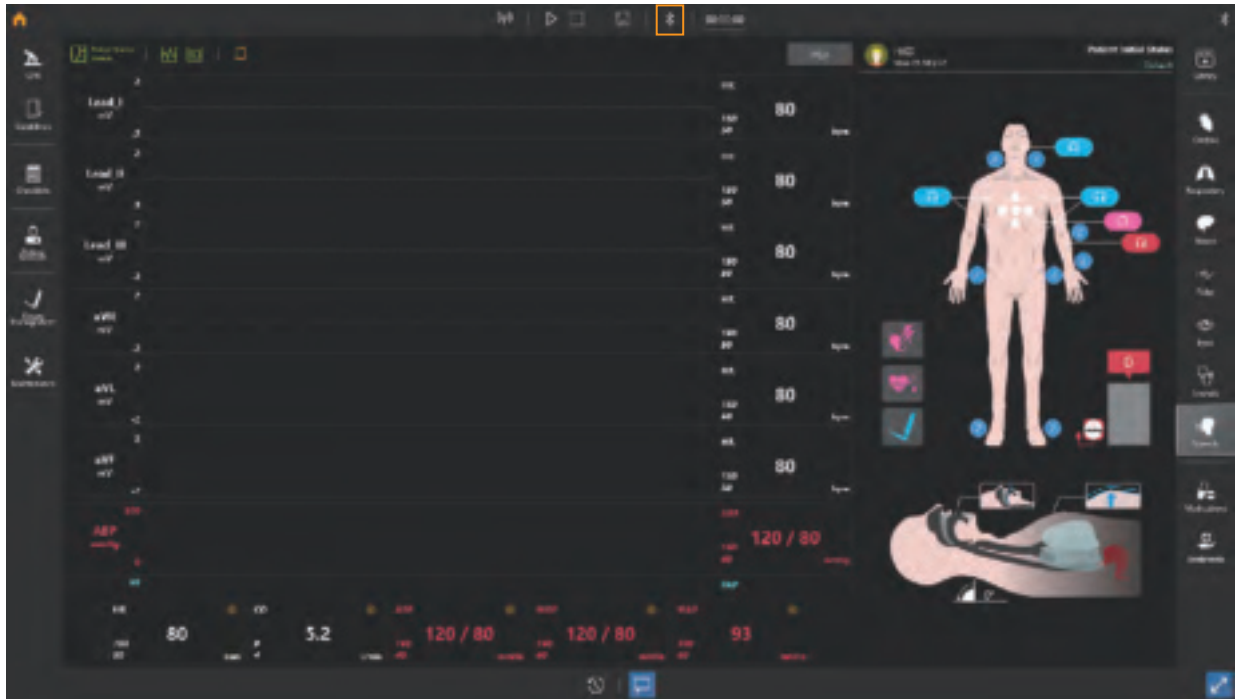

- ③ Find the **manikin's serial number** from Bluetooth list and connect it with the manikin.



④ The Bluetooth connection status can be checked in the upper-right corner.

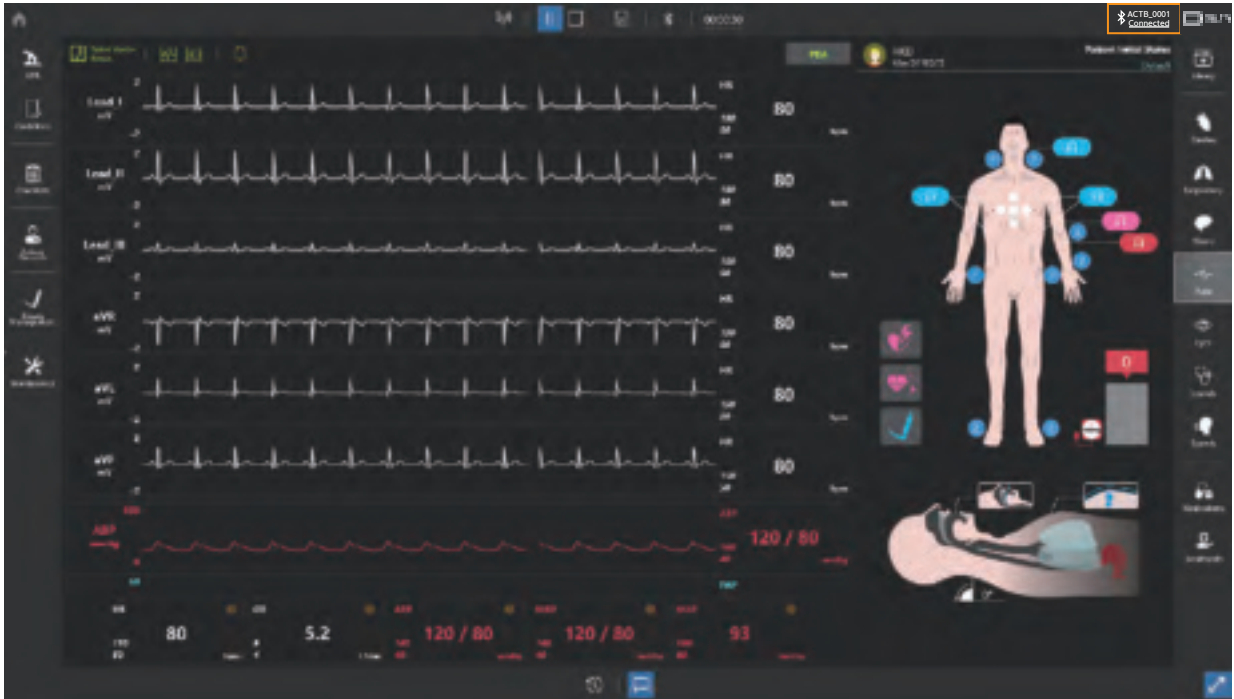

※ If the manikin is not paired to the laptop, the pairing operation is completed automatically.

8. Facilitator Feature

8-1. Manual mode

- ① Select **Manual mode** from the home screen.

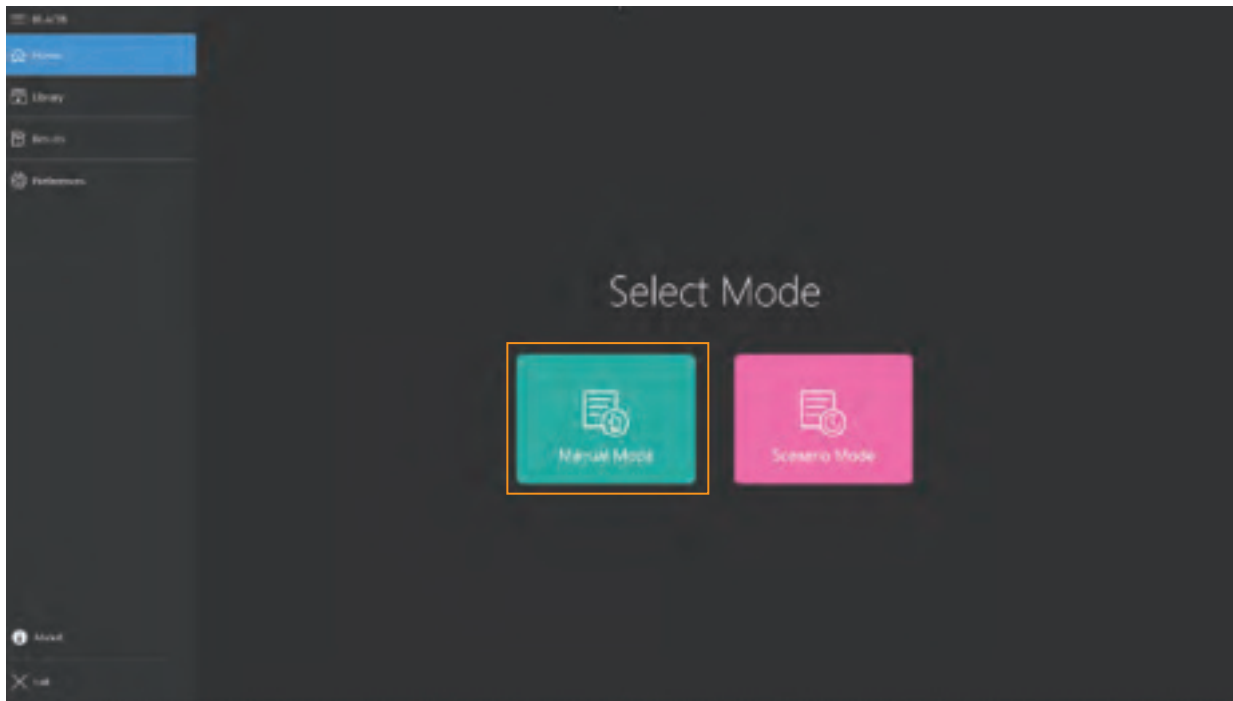







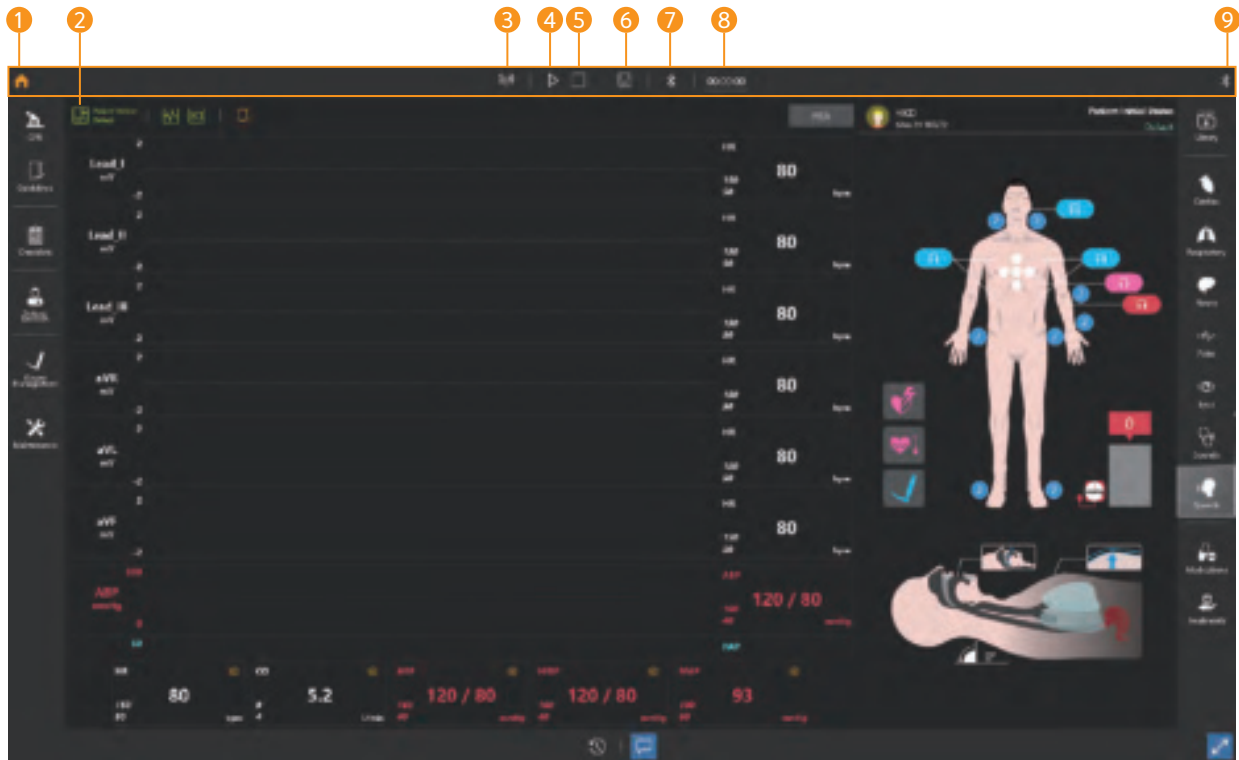

- ② Layout of manual mode



- ① Top menu
- ② Bottom menu
- ③ Left menu
- ④ Right menu
- ⑤ Patient monitor
- ⑥ Patient status viewer

8-2. Top menu



- ① Home  : Go to the home screen.
- ② Patient monitor settings  : Change settings of the layout of patient monitor and the audio.
- ③ Wi-Fi settings  : Connect with Monitor.
- ④ Start training  : Start and pause the training.
- ⑤ End training  : End the training.
- ⑥ Save results  : Save the training result.
- ⑦ Bluetooth settings  : Connect Facilitator to Manikin.
- ⑧ Training time  : Display the training time.
- ⑨ Bluetooth connection status : Displays the manikin connection status.

8-3. Bottom menu

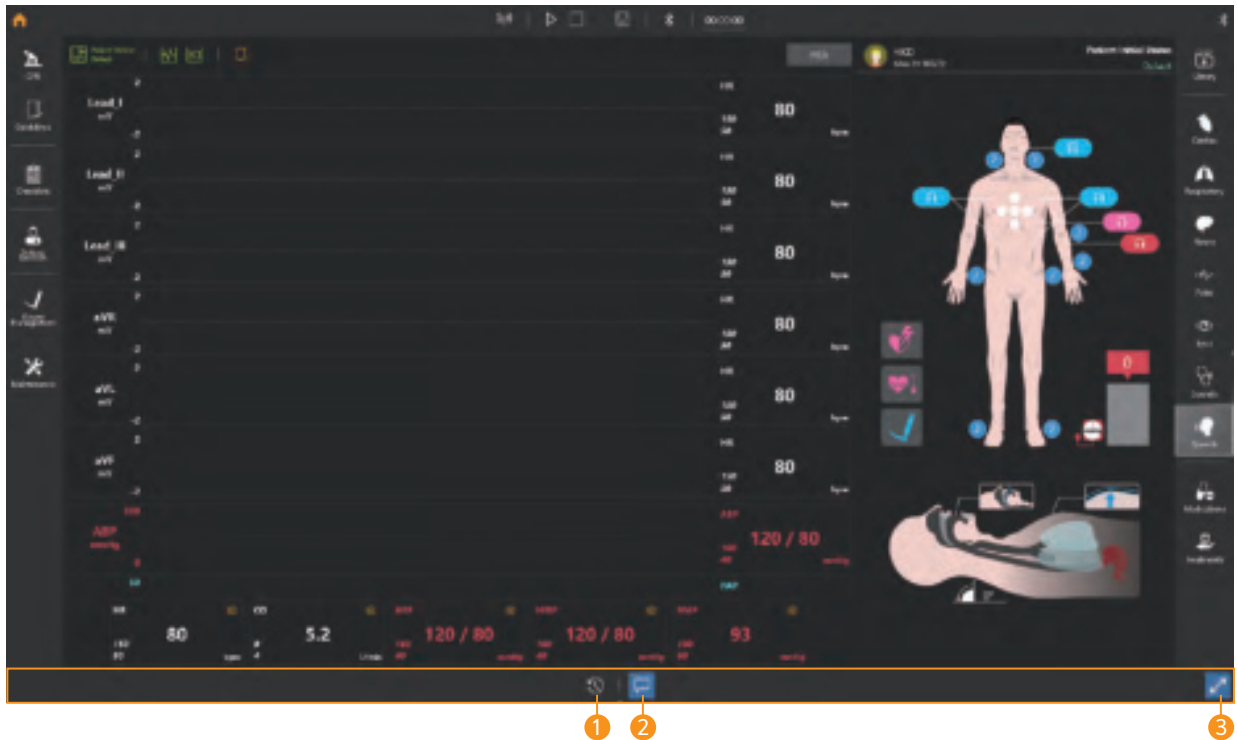

1 Event Logs

- Record changes to parameters, medications, treatments, checklists, and simulators.
- You can select and view the items you want by using the filter.



2 Pop-up message : You can show or hide the pop-up message.

3 Full-screen mode : You can switch to full screen mode.

8-4. Left menu

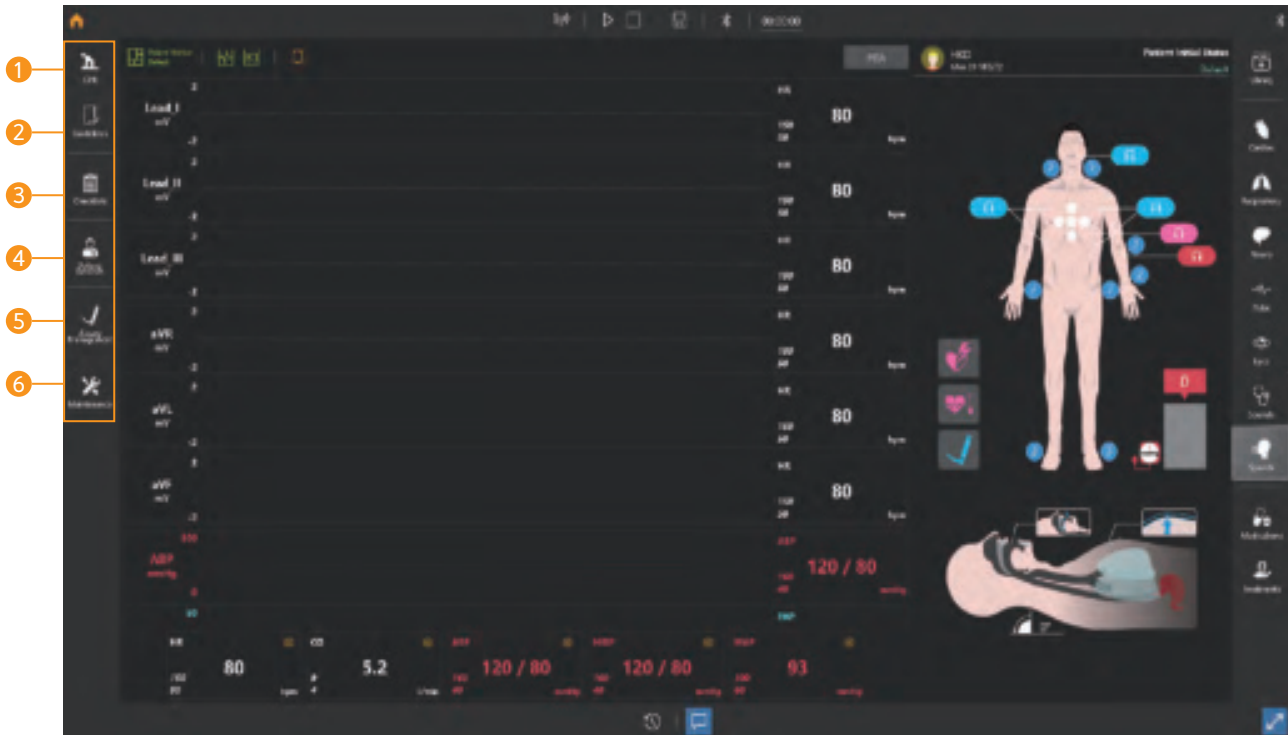

- ① **CPR** : Show the CPR feedback in real-time with graph and chart.
- ② **Guidelines** : You can set CPR guidelines.
- ③ **Checklists** : You can create the checklist for the training.
- ④ **Patient Records**
 - Set or check the patient profile.
 - Send the patient history and diagnostic result.
 - Set or check the initial patient status.
- ⑤ **Airway management** : You can choose the intubation device or set the force on incisors.
- ⑥ **Maintenance** : You can check the simulator's pneumatic operation status or calibrate the sensor values.

8-5. Right menu



- ① **Library** : You can set and save patient parameters at once.
- ② **Cardiac** : You can set cardiac parameters such as cardiac rhythm, heart rate, cardiac output.
- ③ **Respiratory** : You can set respiratory parameters such as chest rising, airway obstruction, respiratory rate.
- ④ **Neuro** : You can set nervous parameters such as ICP, body temperature.
- ⑤ **Pulse** : You can adjust pulse status and the intensity.
- ⑥ **Eyes** : You can set the pupil status.
- ⑦ **Sounds** : You can set heart sounds, lung sounds and Korotkoff sounds.
- ⑧ **Speech** : You can set the speech and the breathing sound.
- ⑨ **Medications** : You can make medications needed for the training.
- ⑩ **Treatments** : You can train defibrillation, pacing, oxygen therapy.

8-6. Patient monitor settings

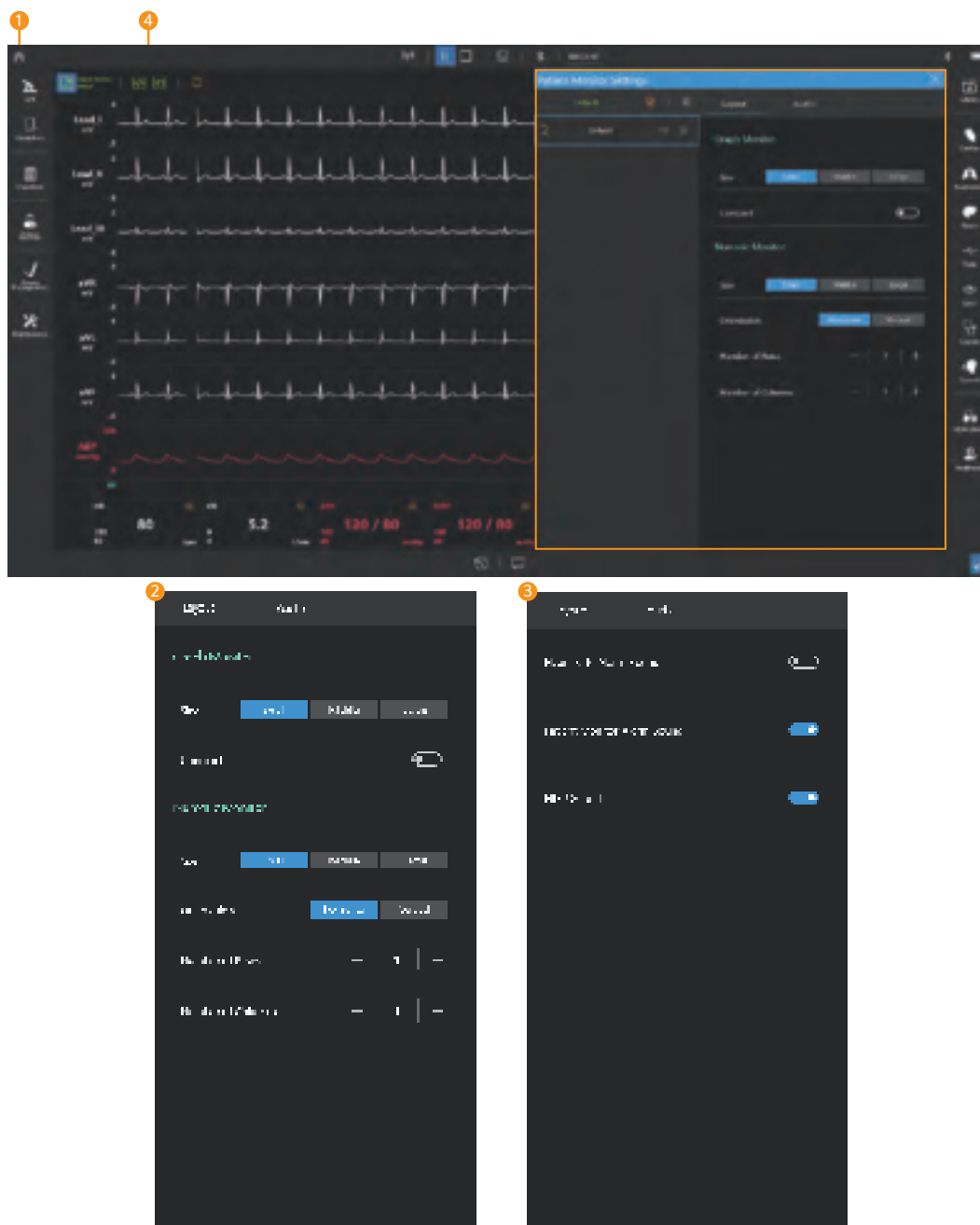

- ① **Patient monitor settings**
 - You can select a saved patient monitor or create a new one.
- ② **Patient monitor layout settings**
 - You can set the layout of the graph monitor and numeric monitor.
- ③ **Audio settings**
 - You can set the heart rate alarm, patient monitor alarm, and NIBP sound.
- ④ **Mute**
 - Turn the sound ON/OFF.

8-7. Patient monitor (Graph monitor)

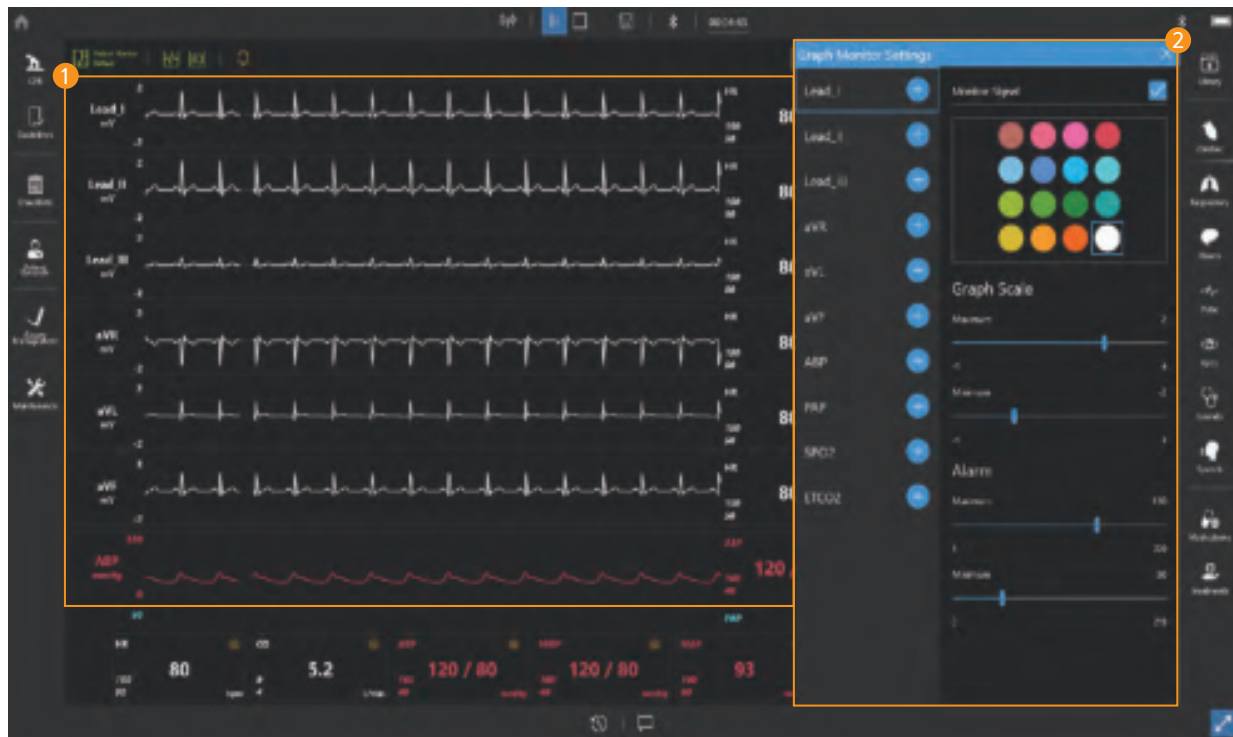

1 Graph monitor

- Display ECG, ABP, PAP, ETCO2 waveform.
- You can change the ECG waveform.

2 Graph monitor settings

- You can add or delete waveforms to the graph monitor.
- You can change the color of the waveform.
- You can display or block the signal of the waveform.
- You can adjust the graph scale.
- You can set the alarm.

8-8. Patient monitor (Numeric monitor)

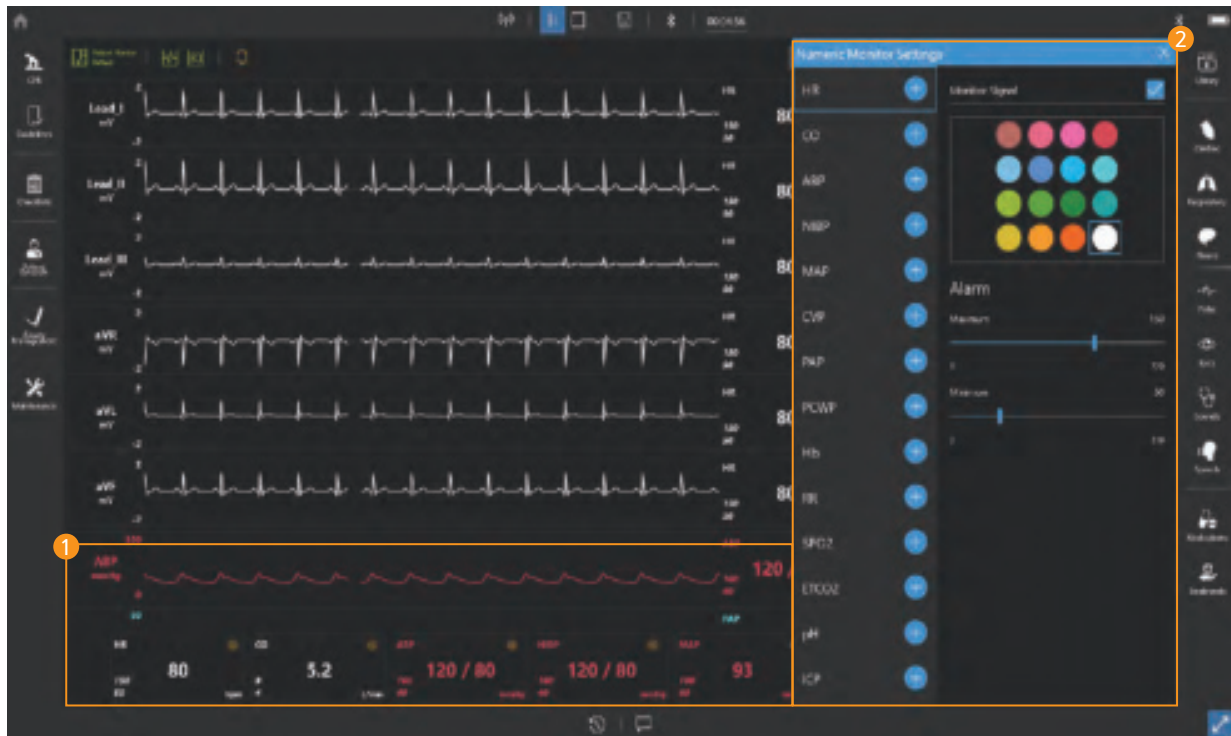

① Numeric monitor

- Display numeric values such as HR, CO, ABP.

② Numeric monitor settings

- You can add or delete patient parameters in the numeric monitor.
- You can change the color of the patient parameters.
- You can show or hide patient parameters.
- You can set the alarm.

8–9. Patient status viewer

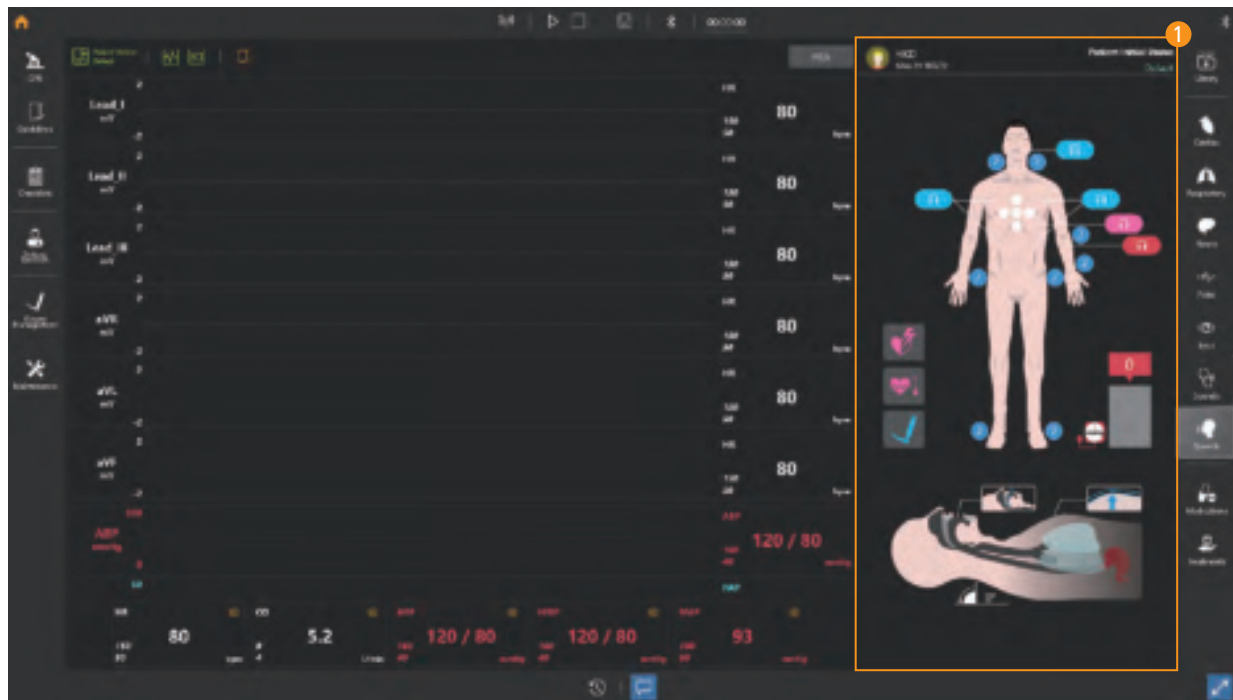

① Display or change the current patient status.

- Display the patient profile.
- Display the hands placement during chest compression.
- Display the pulse intensity and the position of palpation.
- Display the cuff pressure.
- Display heart sounds, lung sounds and the Korotkoff sounds status.
- Display the airway angle.
- Display the jaw thrust maneuver.
- Display the force on incisor.
- Display the position of intubation.
- Display the stomach inflation.
- Display the chest rising and the airway obstruction.
- Display the status of pneumothorax.

8-10. Change the patient status

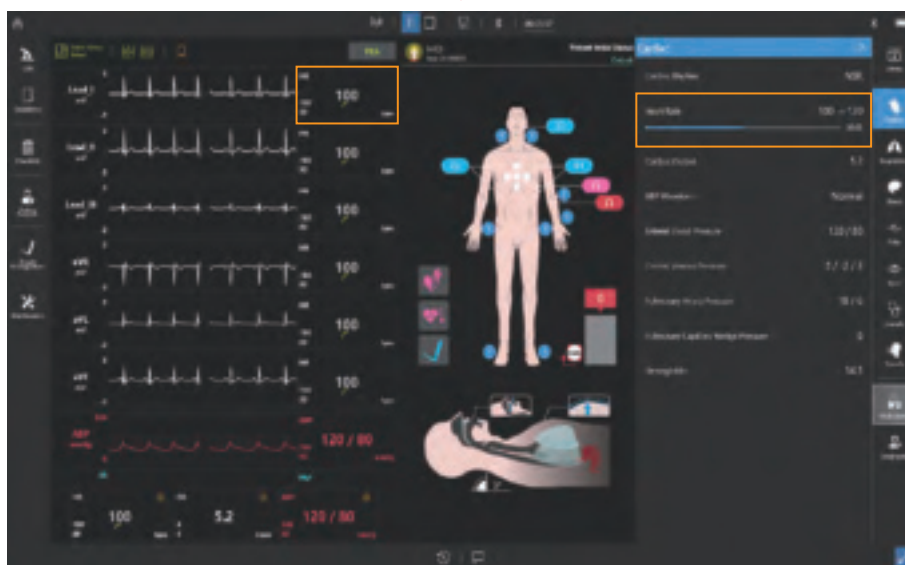
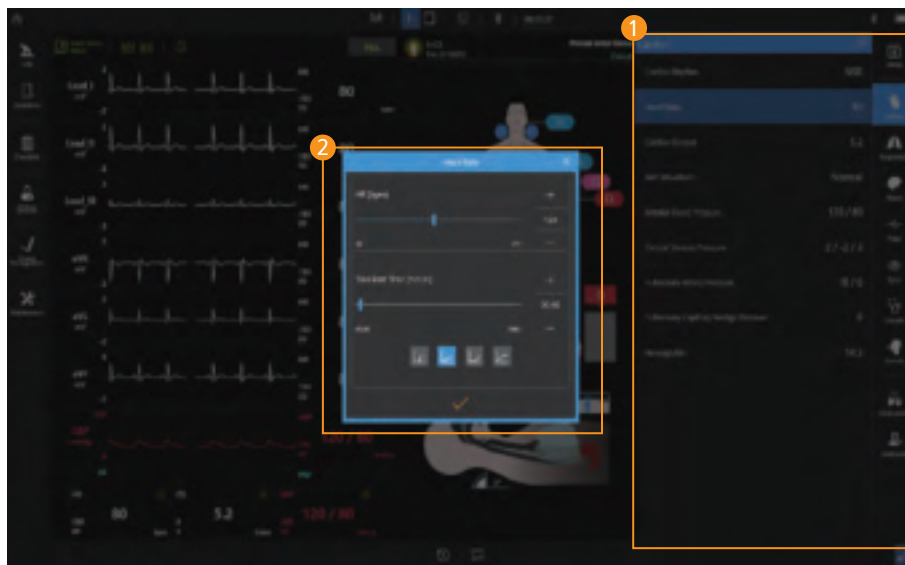

- 1 Select patient parameter menu
 - Select the patient parameter menu that you want to change.
- 2 Set the parameter
 - Change the parameter and transient time.

8-11. Scenario mode

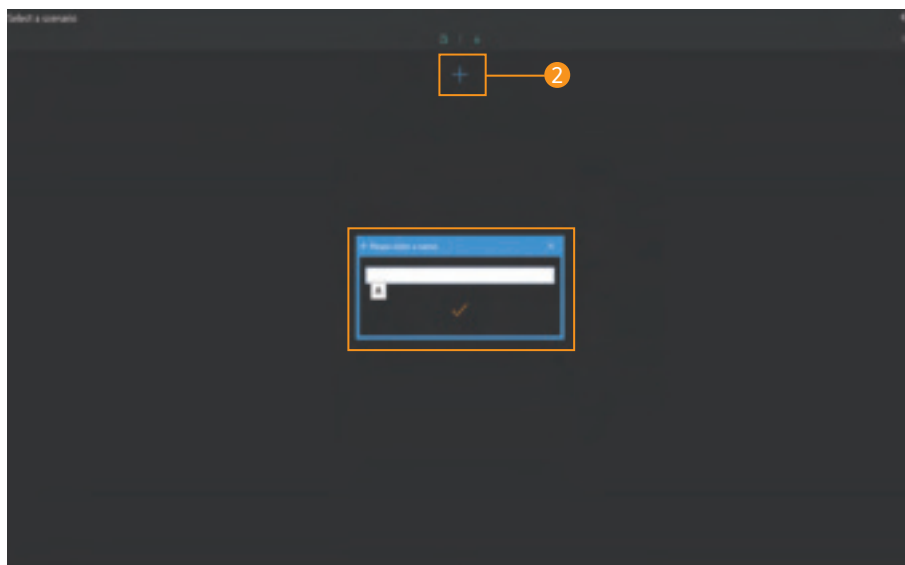
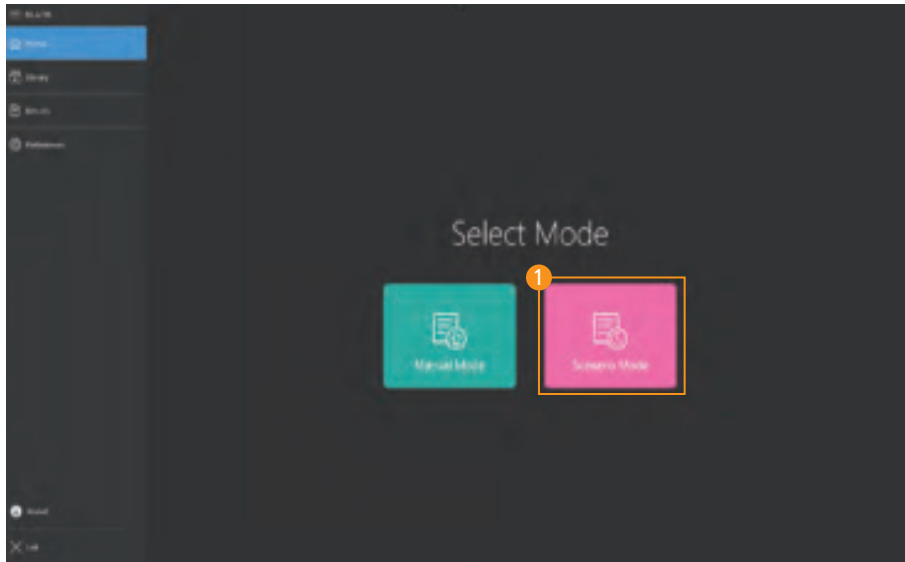

- 1 Start scenario mode
 - Select the scenario mode from the home screen.
- 2 Create a scenario
 - Click the **Add scenario button** and enter a scenario name.

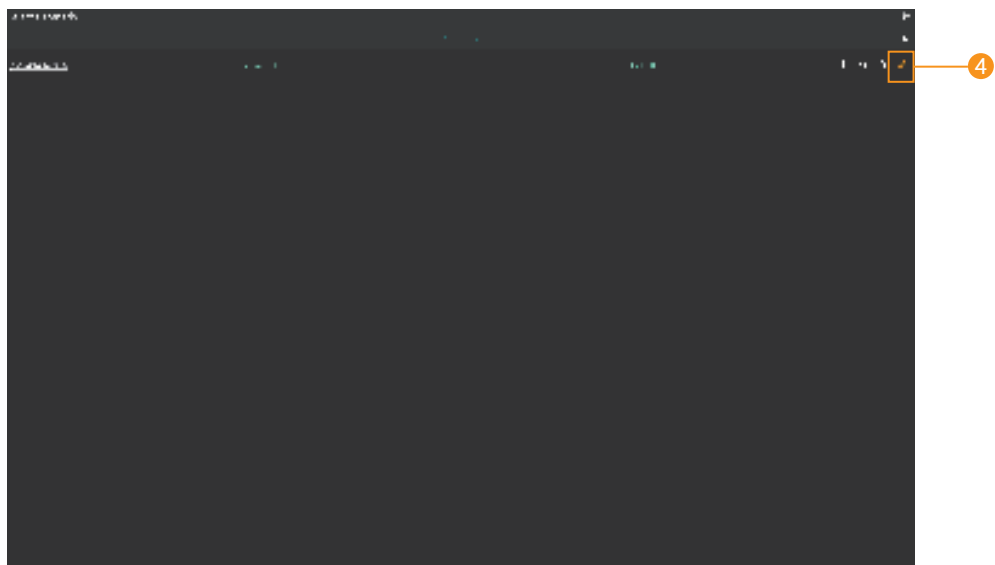
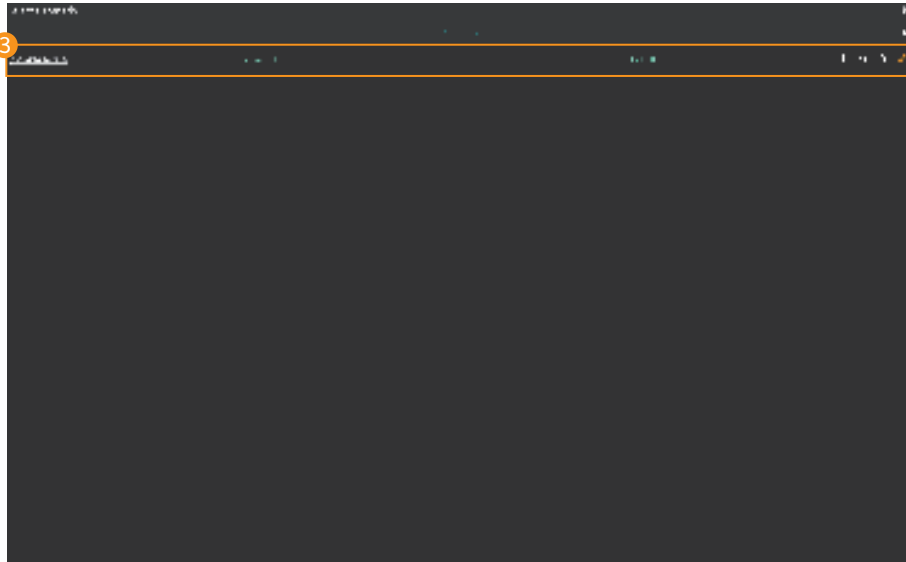

3 Confirm scenario creation

- You can check the scenario created date and name.
- You can check the selected initial patient status.
- You can change the scenario name.
- You can delete the scenario.
- You can copy the scenario.
- You can export or import scenarios.

4 Edit the scenario

- Click the **Edit button** and edit the scenario.

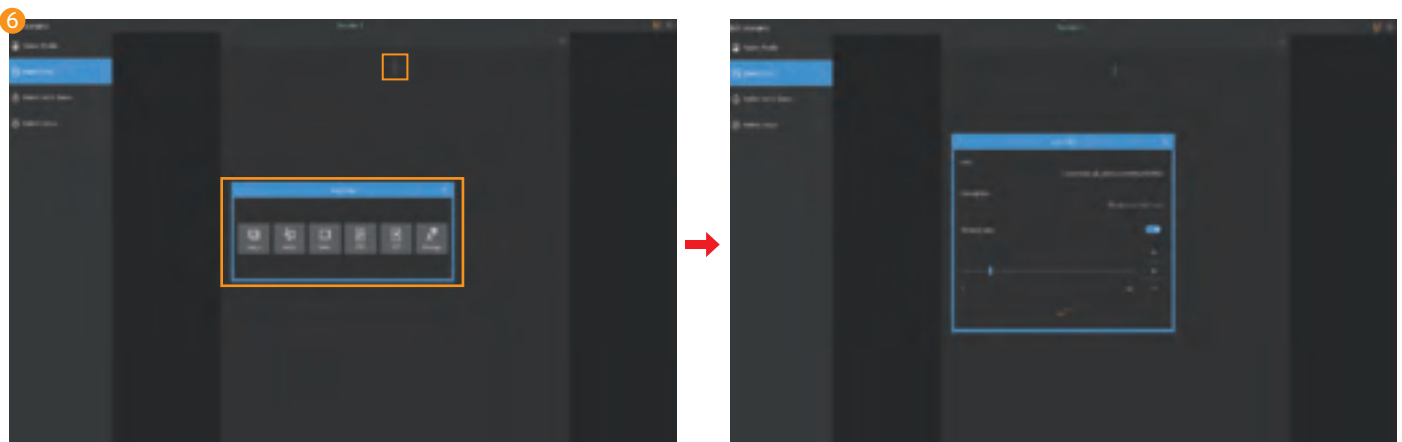
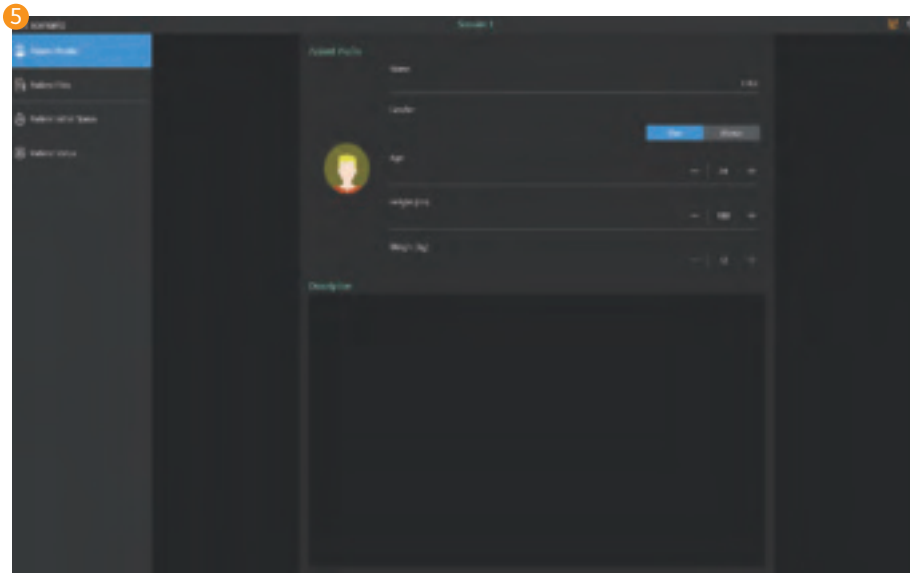

5 Set the patient profile

- Set the patient's name, gender, age, height and weight.
- A brief record of the patient's condition is possible.

6 Add patient file

- File can be saved as image, audio, video, PDF, RTF, text format.
- When adding the file, you can add the brief description and set the display expiration time.

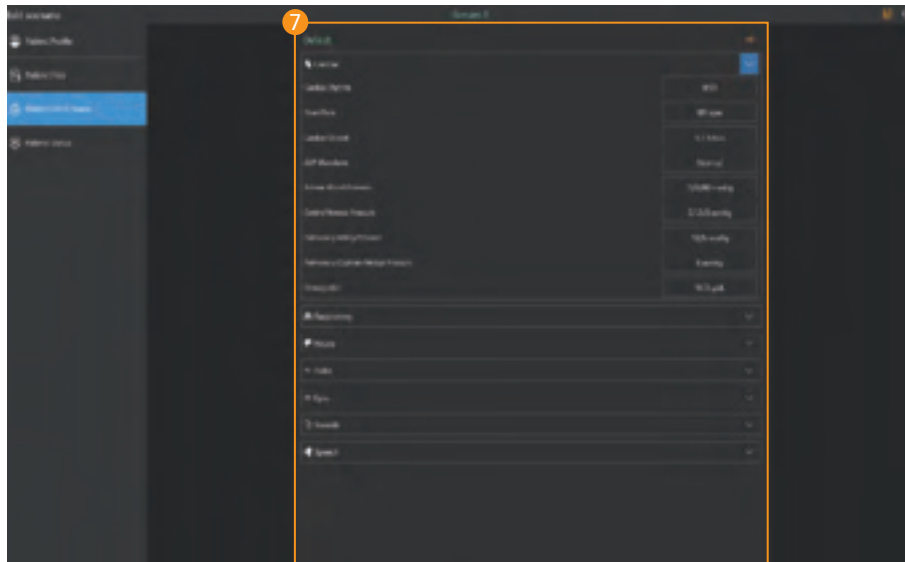

- 7 Set the initial patient status
 - You can set or save the initial patient status.

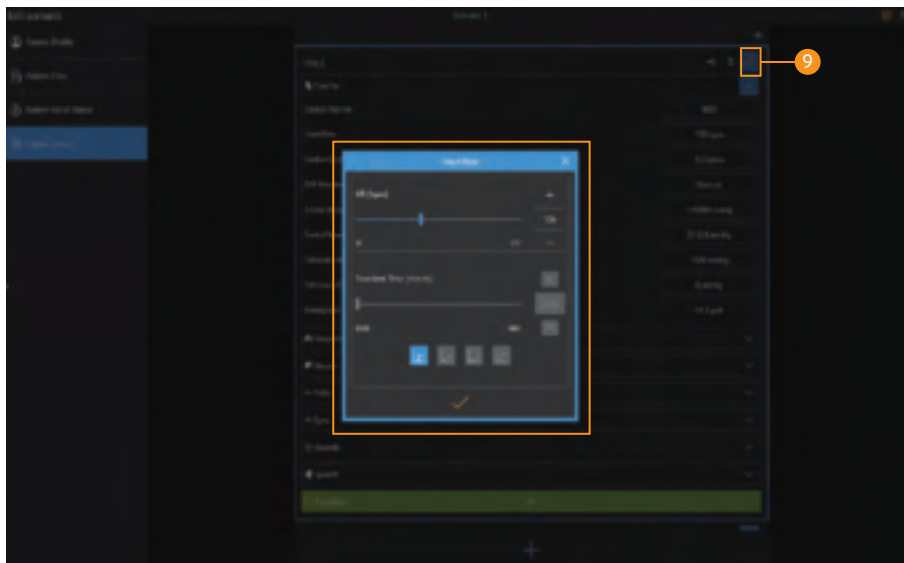
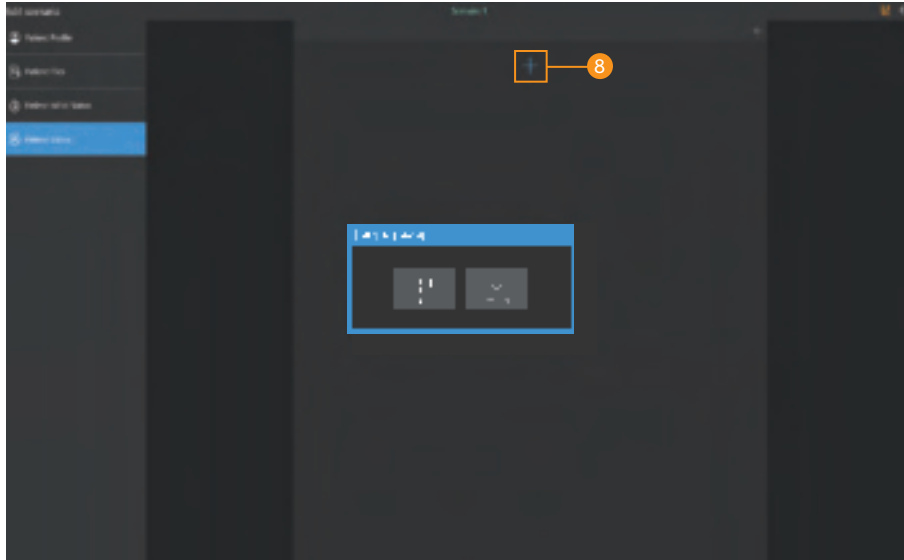

- 8 Add patient status
 - Click the **Add button** to create a patient status needed for the training.
 - You can get patient status from the patient status library.
- 9 Set the patient status
 - Click the **Edit button** to change the patient status.

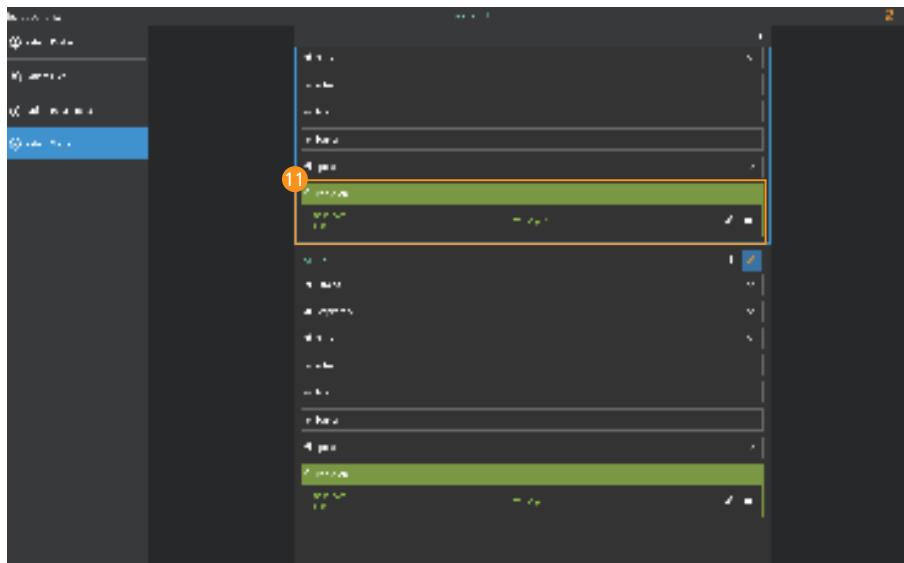
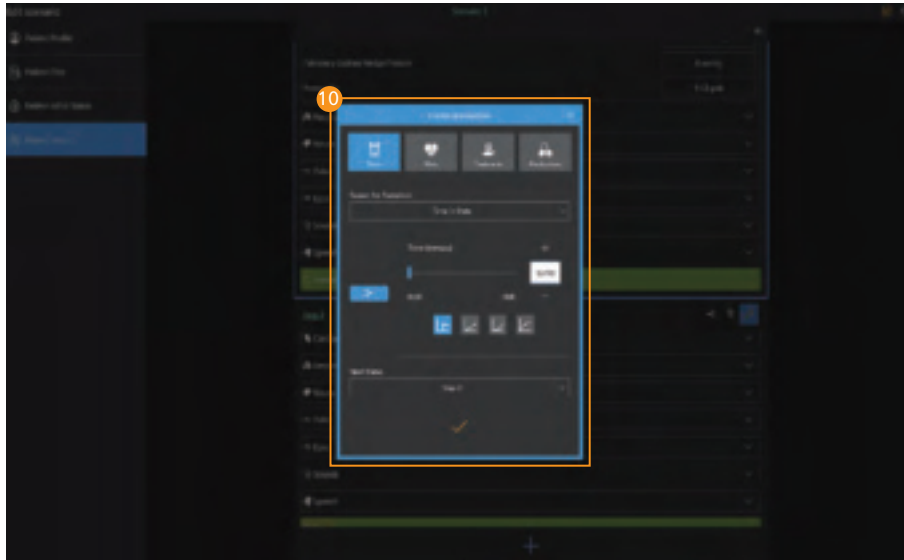

- 10 Create transition
 - You can create transition conditions for changing patient status.
 - There are timer, vital signs, treatments and medications for the transition.
- 11 Check the transition
 - Check the transition condition and the next patient status.

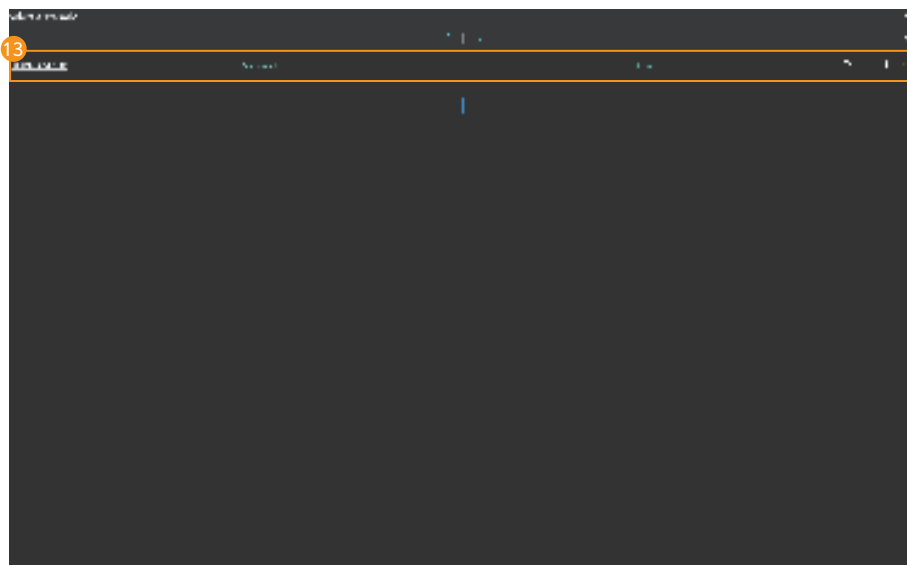
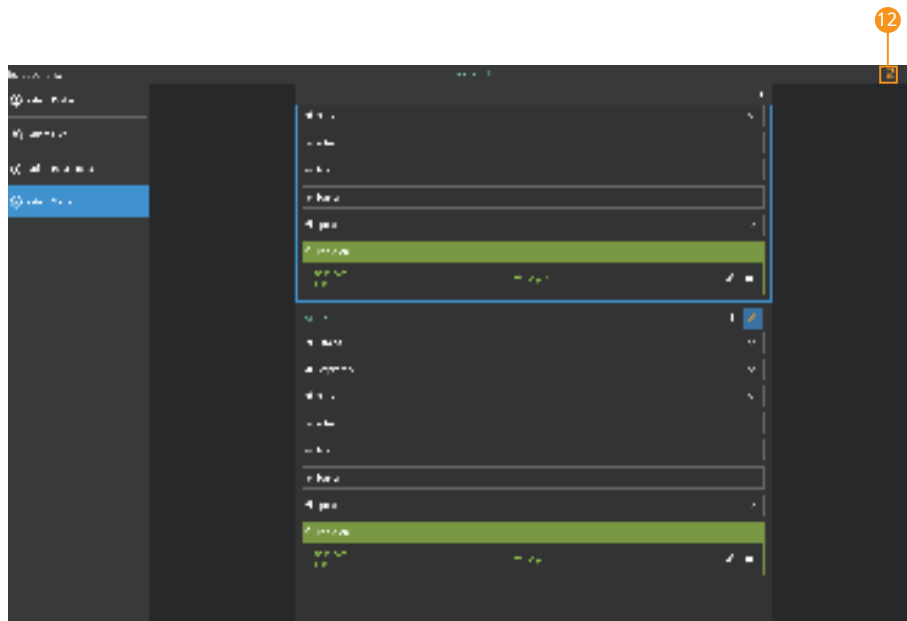

12 Save the scenario

– Click the **Save button** to save the scenario.

13 Start scenario

– Select the scenario that you want to run from the scenario list.

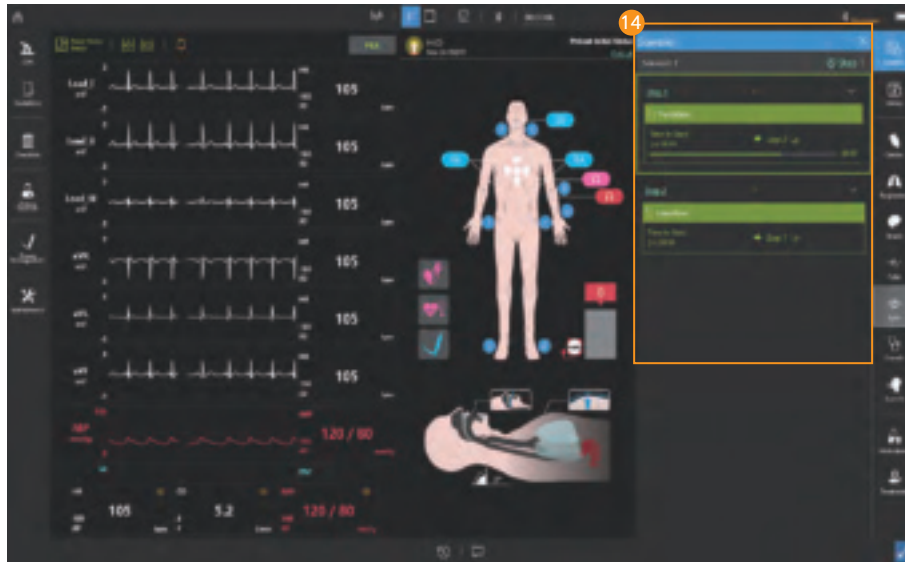

14 Run scenario

- You can start or stop the scenario from the scenario menu.
- You can check the set patient status.

8-12. Library

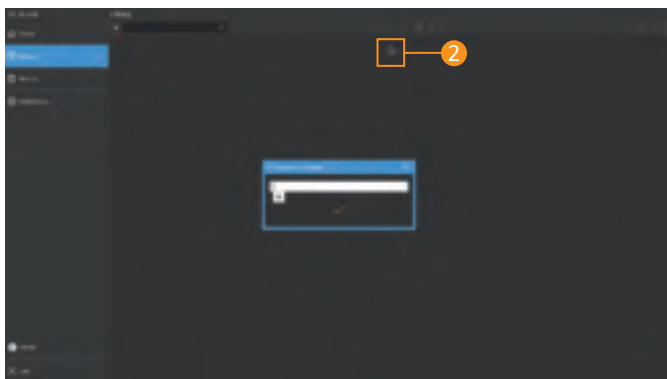
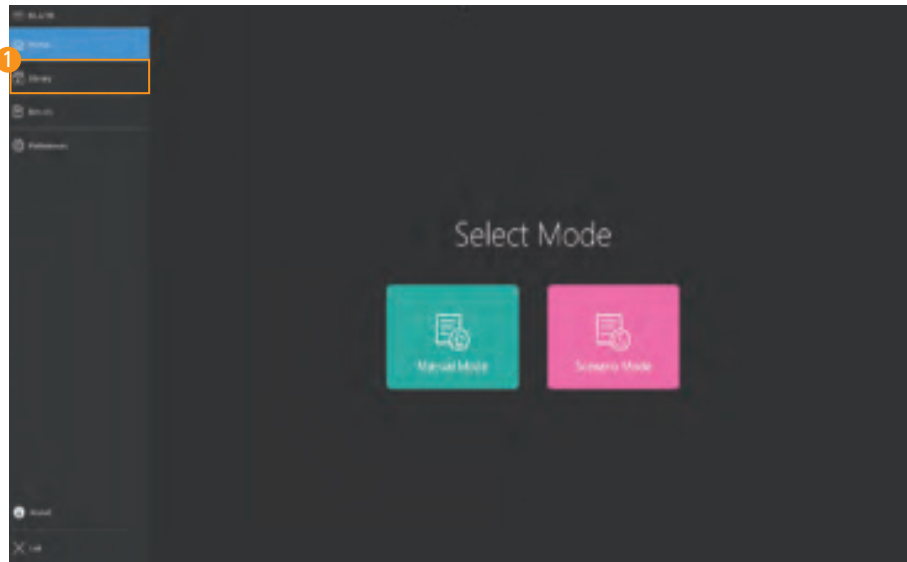

- ① **Select the library menu**
 - Select Library from the home screen.
- ② **Create a library**
 - Click the **Add library button** and enter a library name.
- ③ **Edit the library**
 - You can change or save the patient status by clicking the **Edit button**.
 - You can search for saved patient status.
 - You can change the saved patient status name.
 - You can delete saved patient status.
 - You can copy saved patient status.
 - You can export or import saved patient status.

8-13. View results

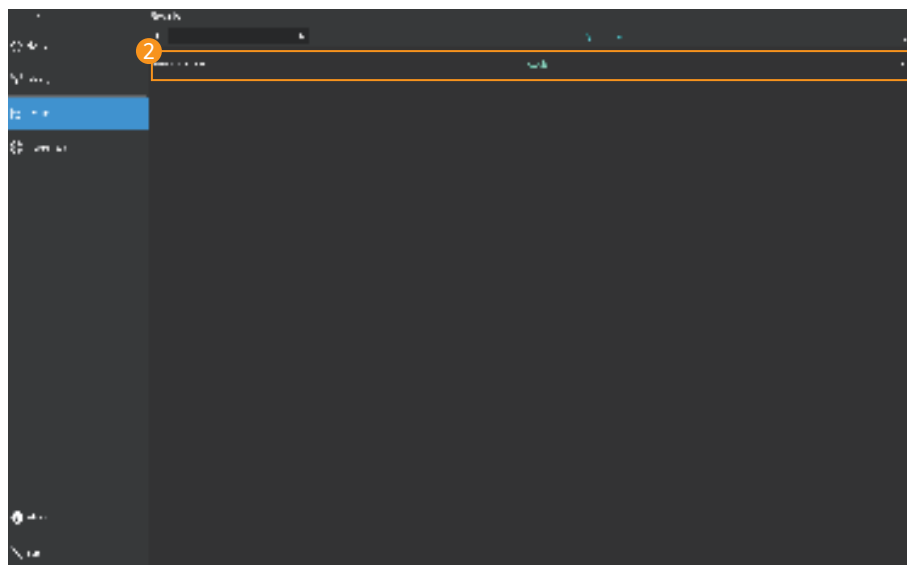
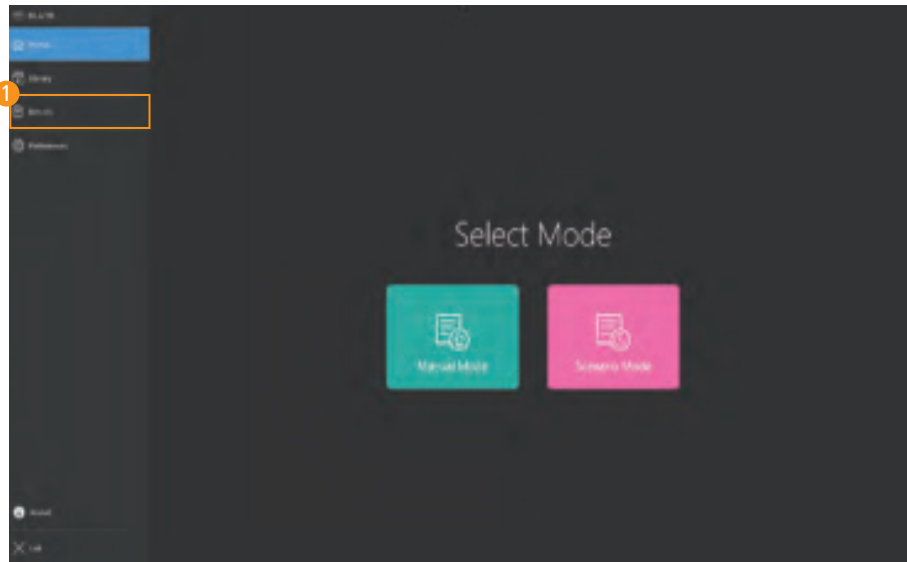

- ① **Select result viewer**
 - Select result viewer from the home screen.
- ② **View saved results**
 - Select the desired result from the result list.
 - You can search saved results.
 - You can change the saved result name.
 - You can delete saved results.
 - You can export or import saved results.

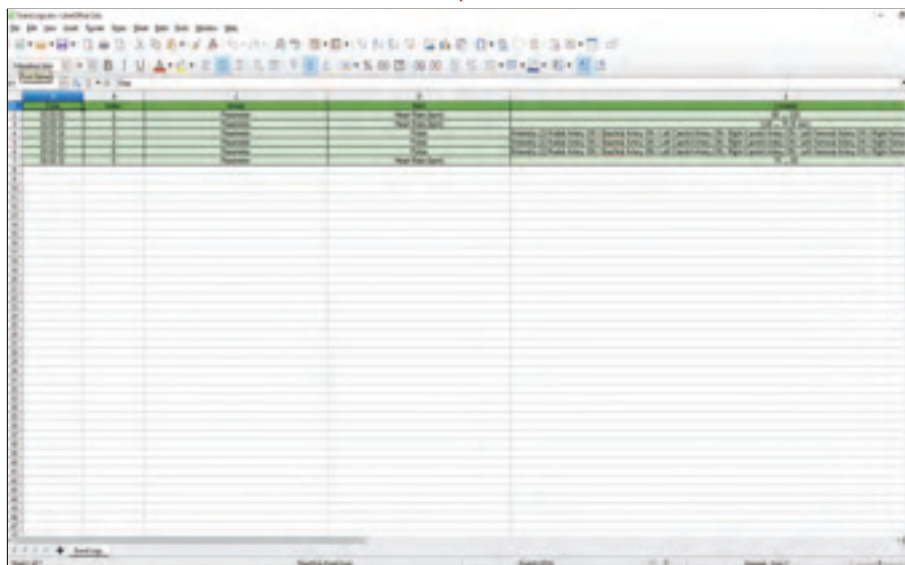

3 Review the event logs

- Review the data such as changed parameters during the training.
- You can view event logs by grouping them.

4 Export to Excel file

- You can export the event logs as an Excel file format.
- You can edit the event logs in Excel or save it with a another name.

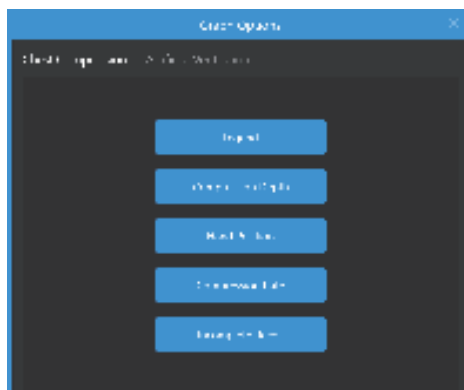
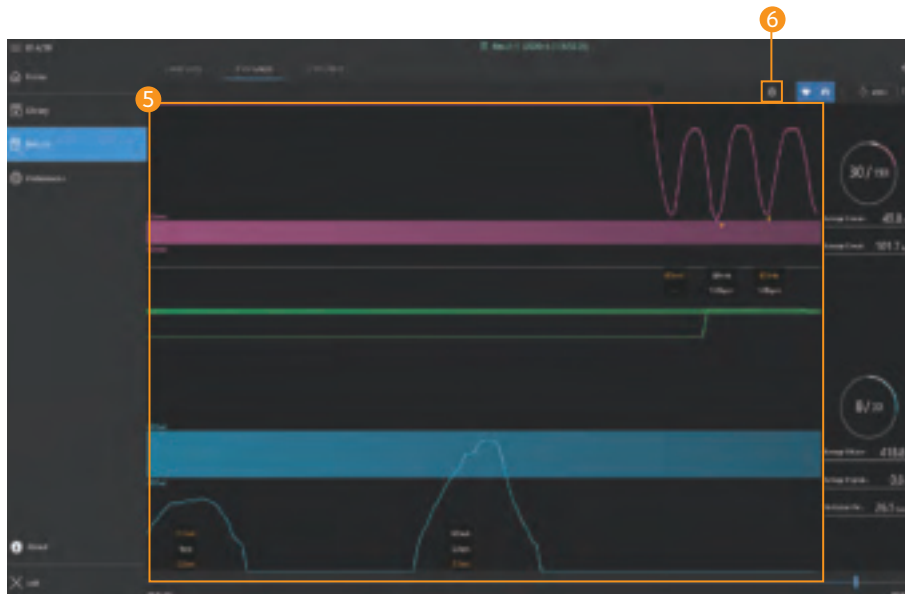

5 View CPR Graph

- Chest compression and ventilation data can be reviewed.
- You can check the CPR data at the desired time using the graph search function.

6 CPR graph options

- You can show or hide chest compressions and ventilation data on the graph.

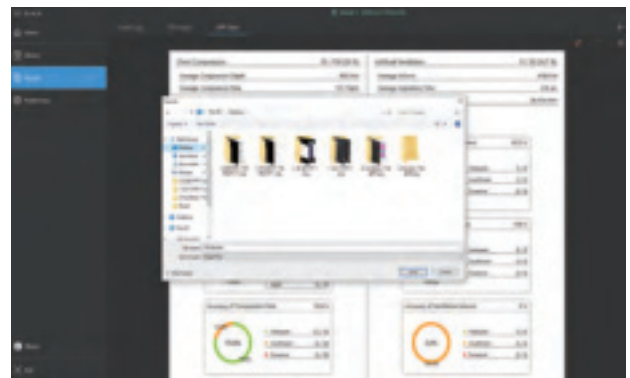
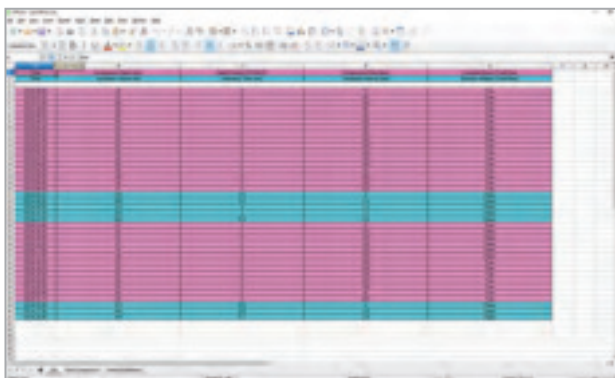

- 7 View CPR chart
 - You can see the CPR results as a chart.
- 8 Export to Excel file
 - You can export CPR data in Excel file format.
- 9 Export to image file
 - You can export or print CPR results in image file format.

9. Monitor Feature







9-1. Patient monitor

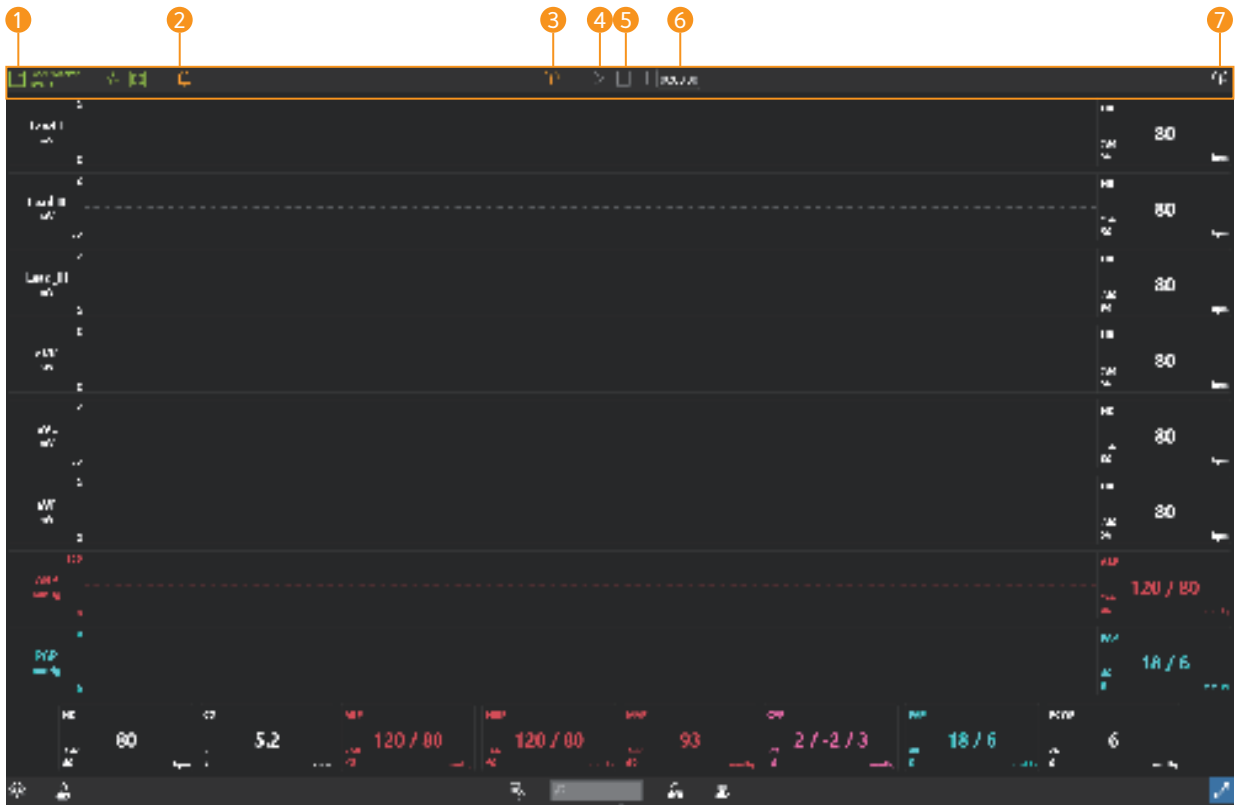

① Top menu ② Bottom menu ③ Patient monitor







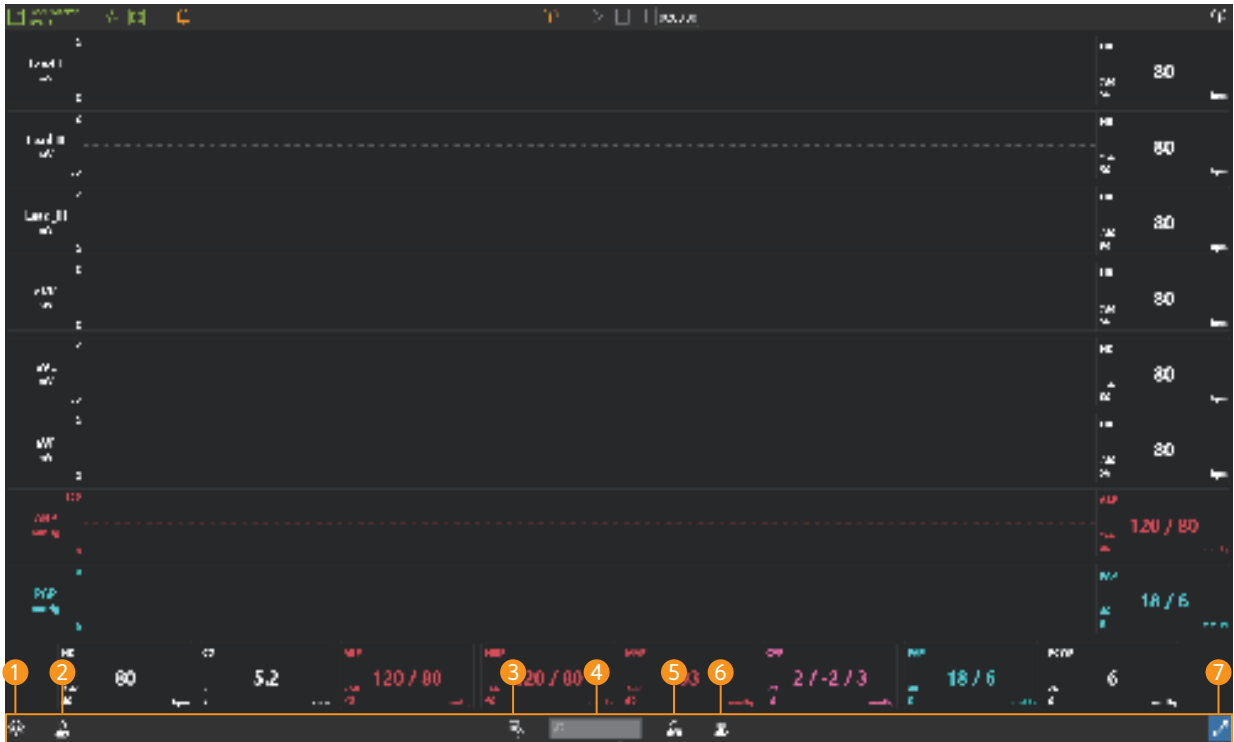

9-2. Top menu



- ① **Patient monitor settings**  : Change settings of the layout of patient monitor, the audio and NIBP.
- ② **Mute**  : Turn the sound ON/OFF.
- ③ **Wi-Fi settings**  : Connect with Facilitator.
- ④ **Start training**  : Displays the start and stop status of the training.
- ⑤ **End training**  : Displays the status of the end of training.
- ⑥ **Training time**  : Display the training time.
- ⑦ **Wi-Fi connection status** : Display the connection status with the Facilitator.

9-3. Bottom menu



- ① **Settings**  : You can check the preferences and S/W information.
- ② **Patient records**  : You can check the patient profile, patient history and diagnostic result.
- ③ **Patient status records**  : You can record or print the current patient status.
- ④ **NIBP**  : You can start measuring NIBP.
- ⑤ **Medications**  : You can choose and administer the medications needed for the training.
- ⑥ **Treatments**  : You can train defibrillation, pacing, oxygen therapy.
- ⑦ **Full-screen mode**   : You can switch to full screen mode.

9-4. Patient monitor settings

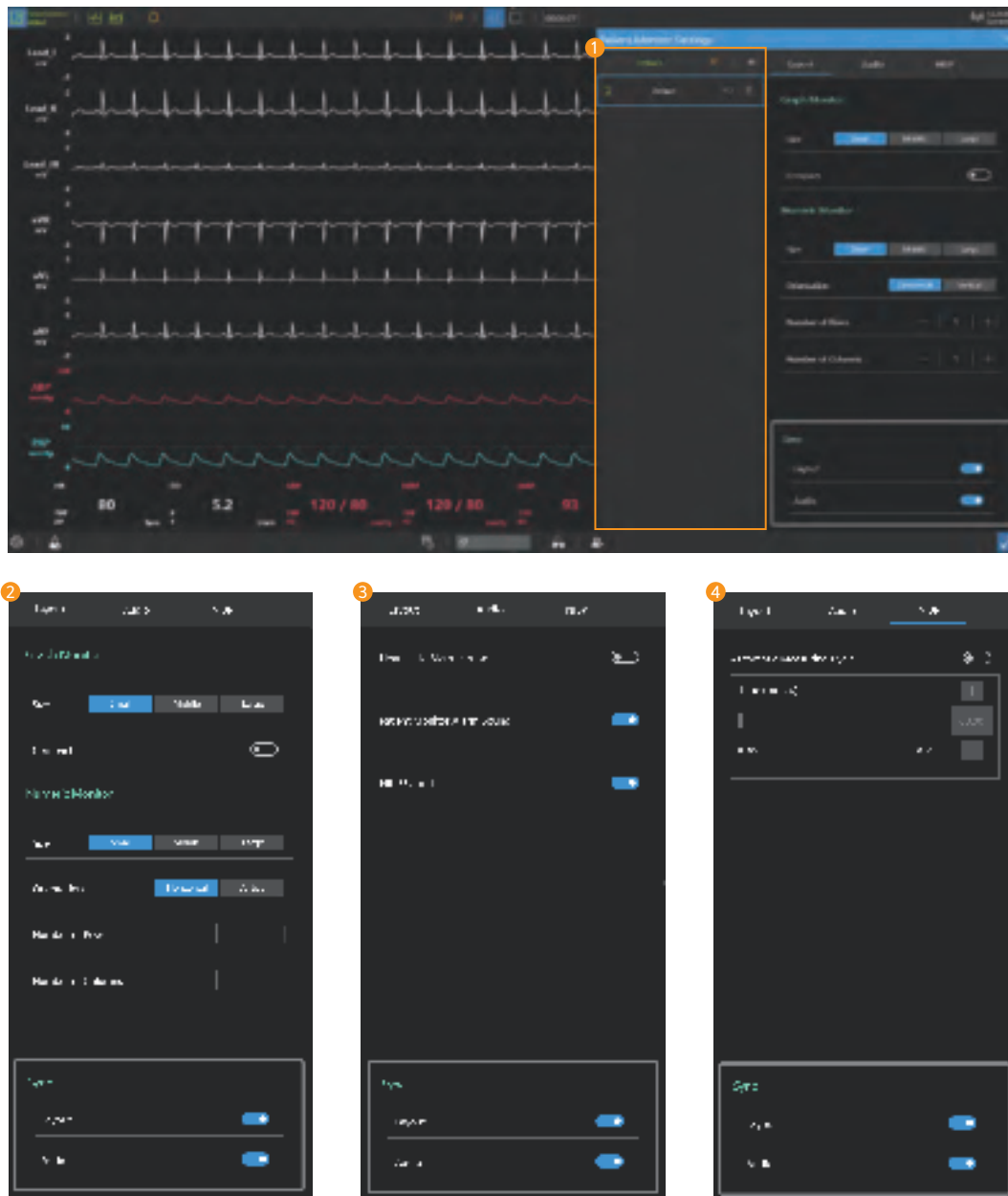

- 1 Select the patient monitor**
 - Select or create a saved patient monitor.
- 2 Patient monitor layout settings**
 - You can set the layout of the graph monitor and numeric monitor.
- 3 Audio settings**
 - You can set the heart rate alarm, patient monitor alarm, and NIBP sound.
- 4 NIBP settings**
 - You can set the NIBP auto cycling.

9-5. Patient monitor (Graph monitor)

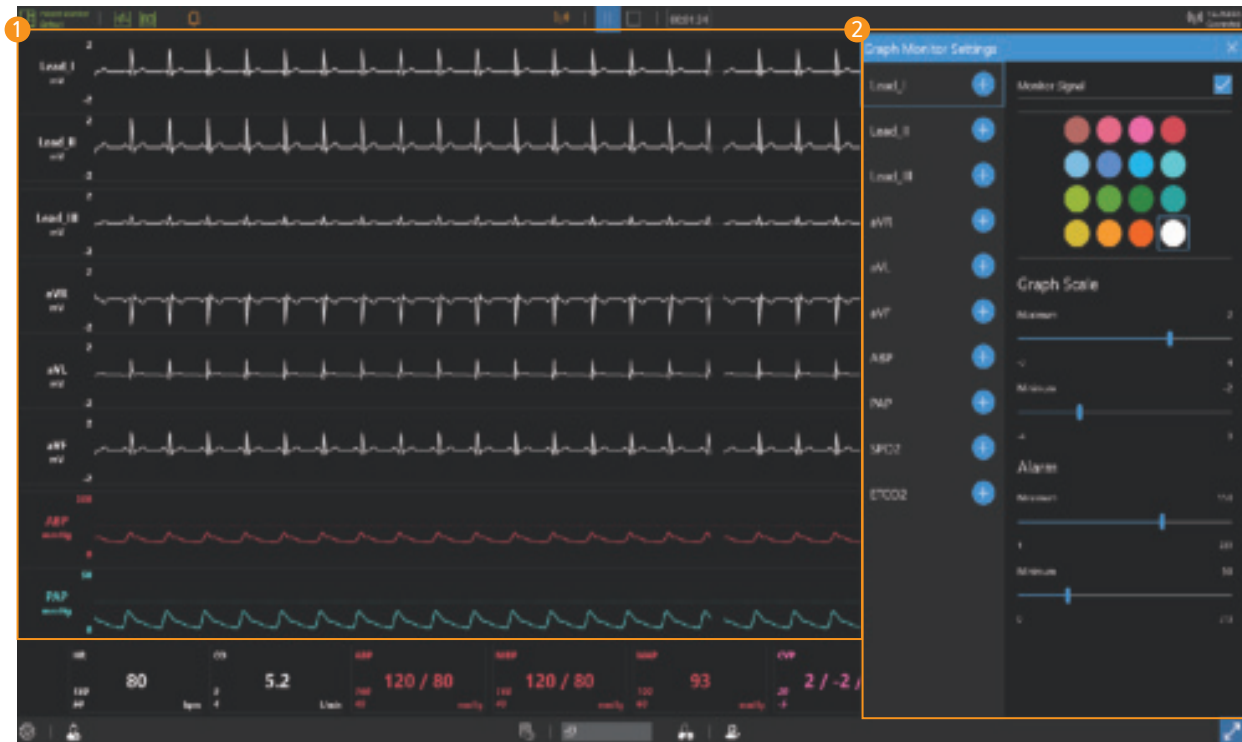

1 Graph monitor

- Display ECG, ABP, PAP, ETCO2 waveform.

2 Graph monitor settings

- You can add or delete waveforms to the graph monitor.
- You can change the color of the waveform.
- You can display or block the signal of the waveform.
- You can adjust the graph scale.
- You can set the alarm.

9-6. Patient monitor (Numeric monitor)

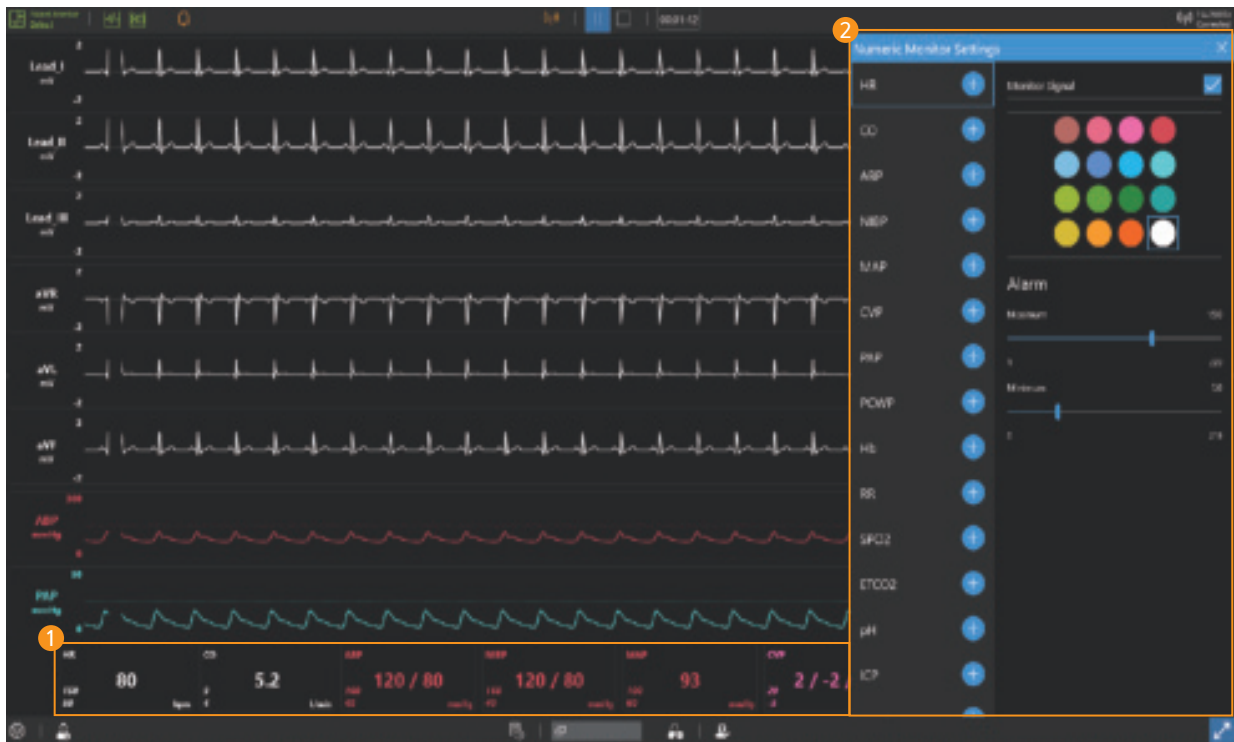

① Numeric monitor

- Display numeric values such as HR, CO, ABP.

② Numeric monitor settings

- You can add or delete patient parameters in the numeric monitor.
- You can change the color of the patient parameters.
- You can show or hide patient parameters.
- You can set the alarm.

9-7. Patient records

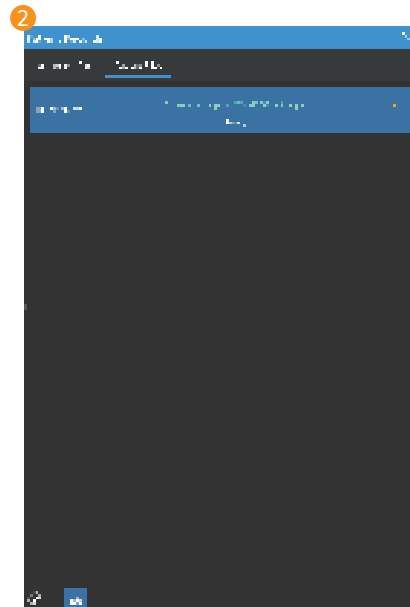
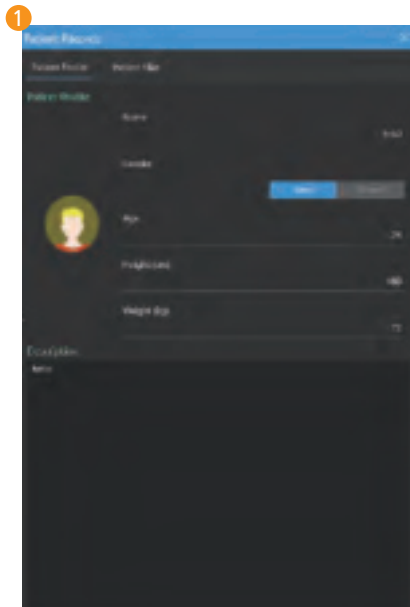

- ① **Patient profile**
 - You can check the current patient profile.
- ② **Patient files**
 - Patient files sent from Facilitator are saved.
 - Click the **Open file button** to view the patient file.

9-8. NIBP

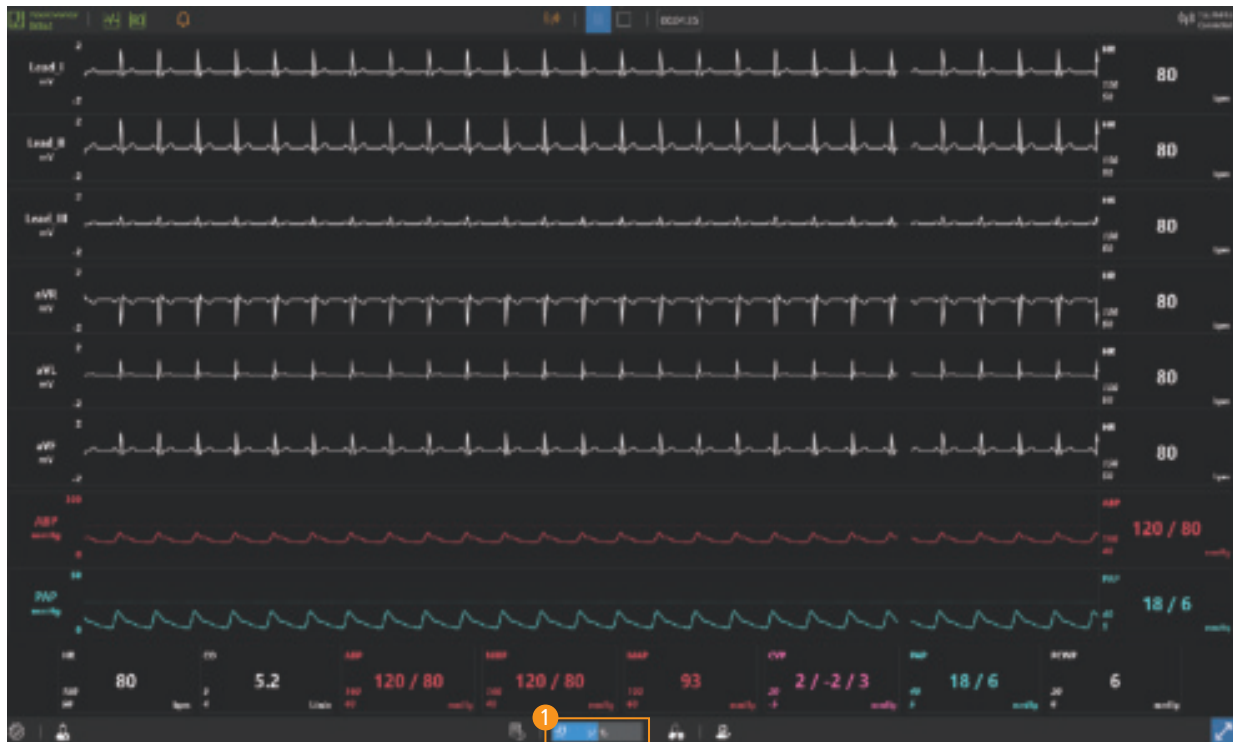

① Measure NIBP

- Click the mouse to start the NIBP measurement.
- NIBP is automatically measured when the NIBP auto cycling is set.

9-9. Medications

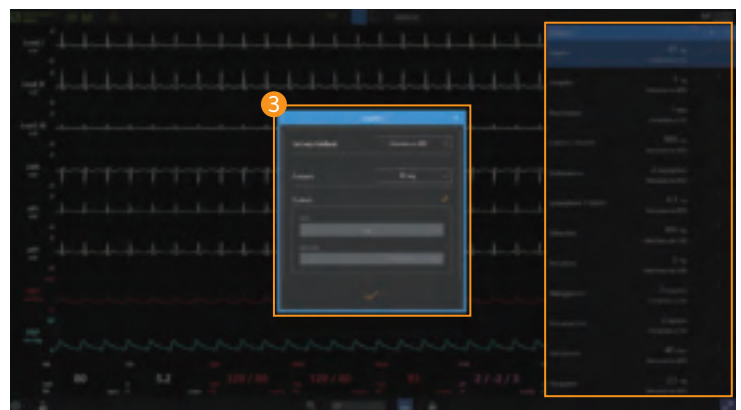
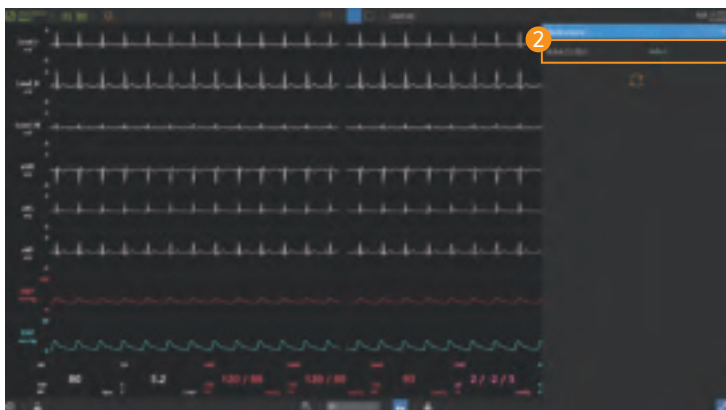
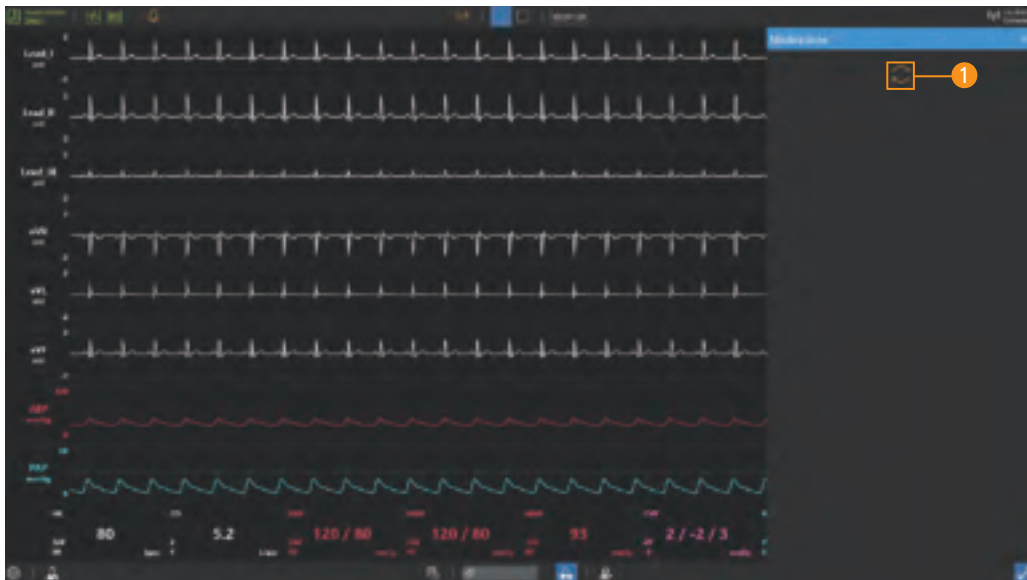

- ① **Bring medications**
 - Click the **Import medication button** to import medication stored in the Facilitator.
- ② **Select medication**
 - You can choose the medication you need for your training from the medication list.
- ③ **Medication administration**
 - You can choose the type of medication and set the dosage and medication method.

9–10. Defibrillator

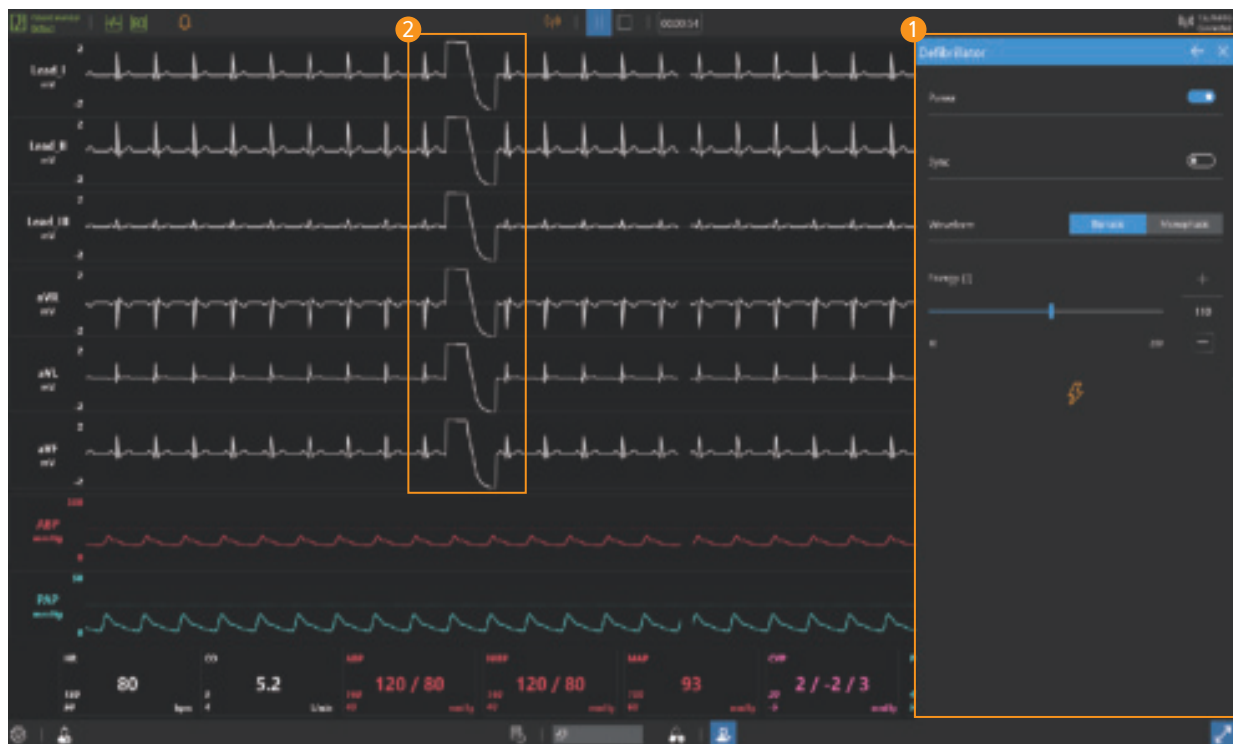

1 Defibrillator

- You can train synchronous and asynchronous defibrillation.
- You can select the type and energy of the defibrillation waveform.

2 Defibrillation waveform

- Defibrillation waveforms are displayed on the ECG graph during defibrillation.

9–11. Pacer



1 Pacer

- You can set pacing current and rate.
- You can set the patient threshold current.

2 Capture beats

- When pacing current is applied, capture beats are displayed on ECG graph.

9–12. Oxygen therapy

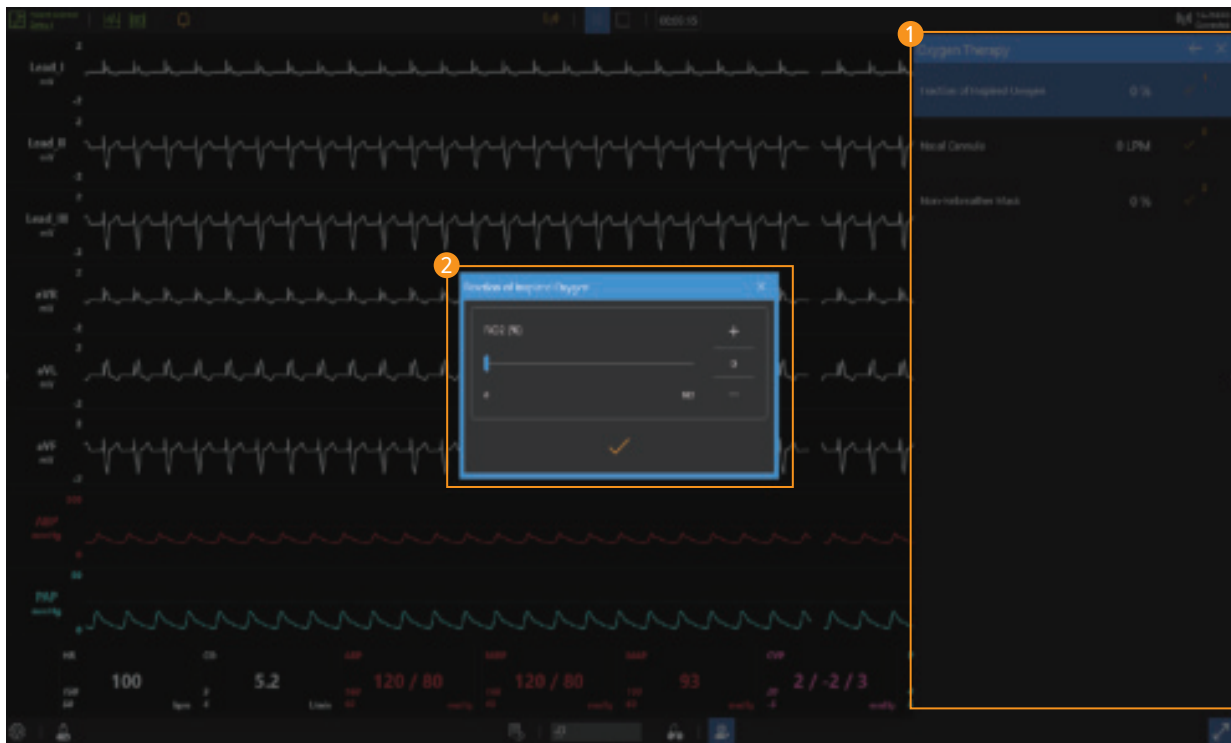

- 1 **Select oxygen therapy**
 - You can choose the oxygen therapy that such as fraction of inspired oxygen and nasal cannula.
- 2 **Set the oxygen therapy**
 - You can set appropriate FiO₂ and flow rate for the patient treatment.

9-13. Patient status records

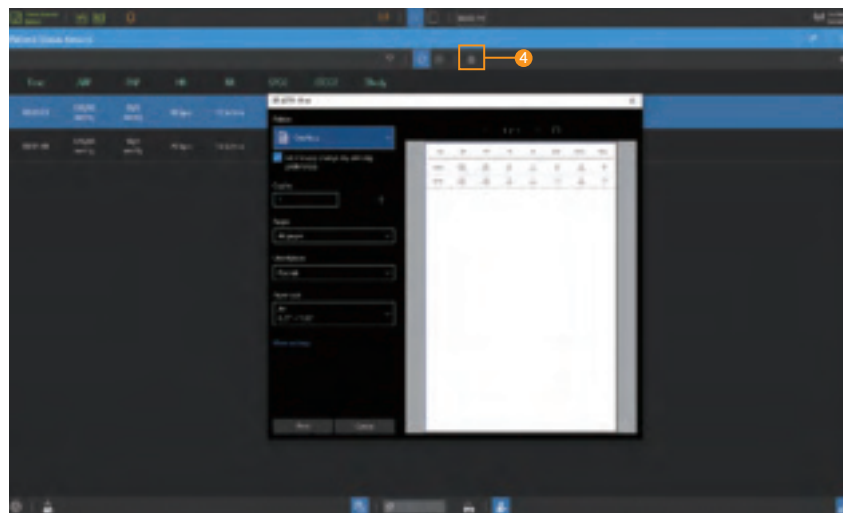
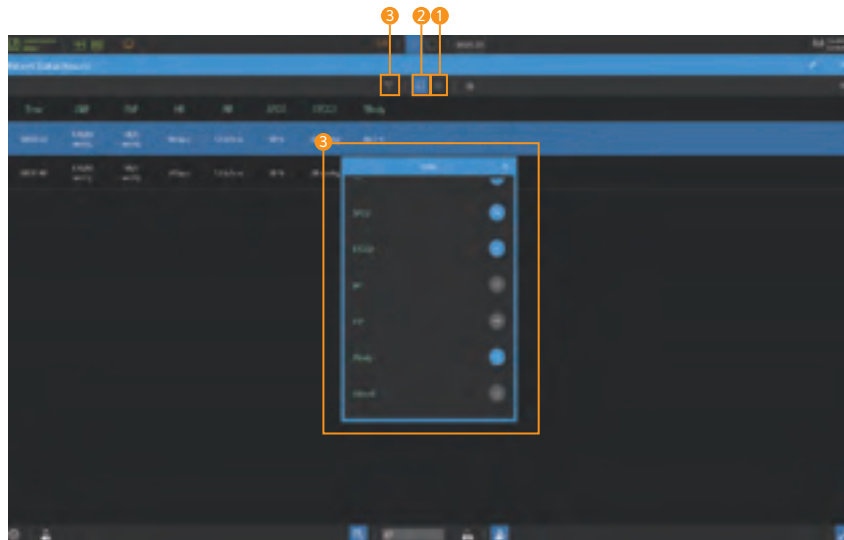

- ① **Patient status records**
 - Click the **Capture button** to record the current patient status.
- ② **Auto record**
 - Automatically recorded when patient status changes.
- ③ **Set filters**
 - Use the filter to add or delete the currently recorded patient status parameters.
- ④ **Printing the patient status records**
 - You can print the patient status record by clicking the **Print button**.

ALS Simulator BT-ACTB

A-313, Samsung Techno-valley, 140, Tongil-ro, Deogyang-gu, Goyang-si,
Gyeonggi-do, 10594, Republic of Korea

T : +82-2-2038-2903

F : +82-2-2038-2904

www.btinc.co.kr / bt@btinc.co.kr



BT Inc.
BEST TECHNOLOGY & BETTER TOMORROW