

USER GUIDE

Arm Manikin for IV Access Training

(Infants Arm Manikin, Model : BT-CSIV-I)



1. Cautions

- **This manual describes how to use BT-CSIV-I Properly.
Read it carefully to avoid damaging the product and injuring yourself.
Pay attention to the following series of warnings.**

- ① Use only components provided or approved by BT Inc.
- ② Do not disassemble, repair, or modify this product on your own.
- ③ Keep the product away from water. If the product gets wet, do not turn it on. You could be injured by electric shock.
- ④ Do not use the product near strong magnetic fields or high voltage power lines. The product might malfunction due to electromagnetic waves.
- ⑤ Do not use the product under a condition of thunder and lightning. It can cause the product malfunction and increases the risk of electric shock.
- ⑥ Do not use the product in locations with temperatures below 0°C or above 40°C.

(Operation temperature : 0°C ~ 40°C, Storage temperature : -10°C ~ 50°C)

- ⑦ Do not keep the product near hot places such as heaters. Transformation of product or internal damage might occur.
- ⑧ Never clean the product with chemical substances such as solvent, benzene or thinner, as these may cause ignition, electric shock or cause the surface to deteriorate.
- ⑨ BT Inc. can change or adjust the product specification without any notice in order to improve the product.

2. Contents

1. Cautions	1
2. Table of Contents	2
3. Components	3
4. Features and Functions	4
5. Installation	6
6. User Manual	8
7. Cleaning and Storage	10

3. Components

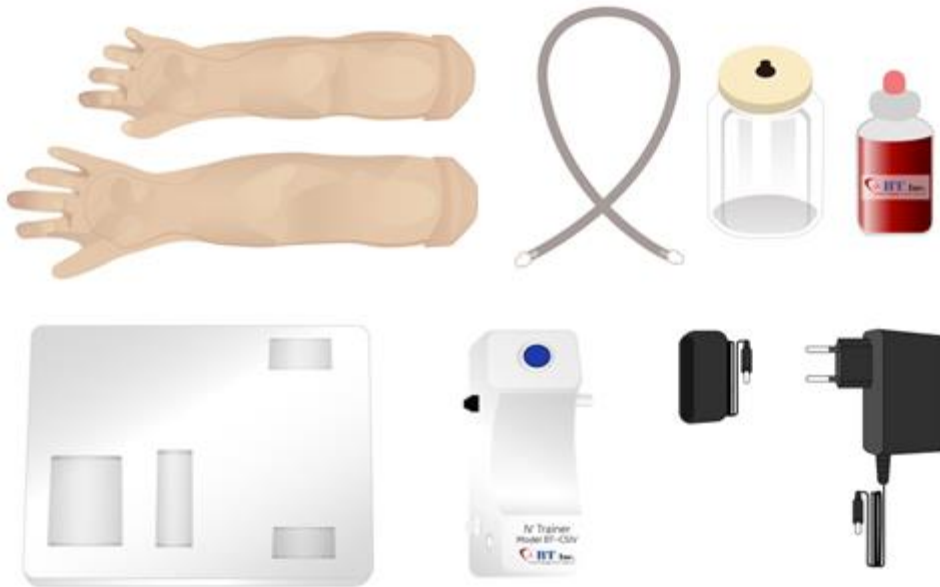

(1) Left Infants Arm Manikin

- ① Infants Arm Model(Vein Tube installed) – 2ea

(2) Pump Driving Device

- ① Peristaltic pump (installed) – 1ea
- ② Microprocessor controller (installed) – 1ea
- ③ Arm Mount adapter – 1ea

(3) Accessories

- ① Mount – 1ea
- ② Simulated blood (30ml) – 1ea
- ③ Plastic bottle – 1ea
- ④ Power source adapter (9VDC) – 1ea
- ⑤ Battery Holder – 1ea
- ⑥ Connection tube – 3ea
- ⑦ Storage case – 1ea

4. Features and Functions

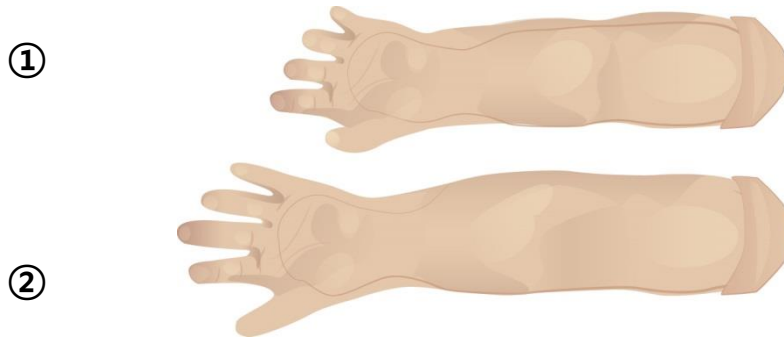

① 1 Year Infant Arm model

② 3 Year infant Arm model

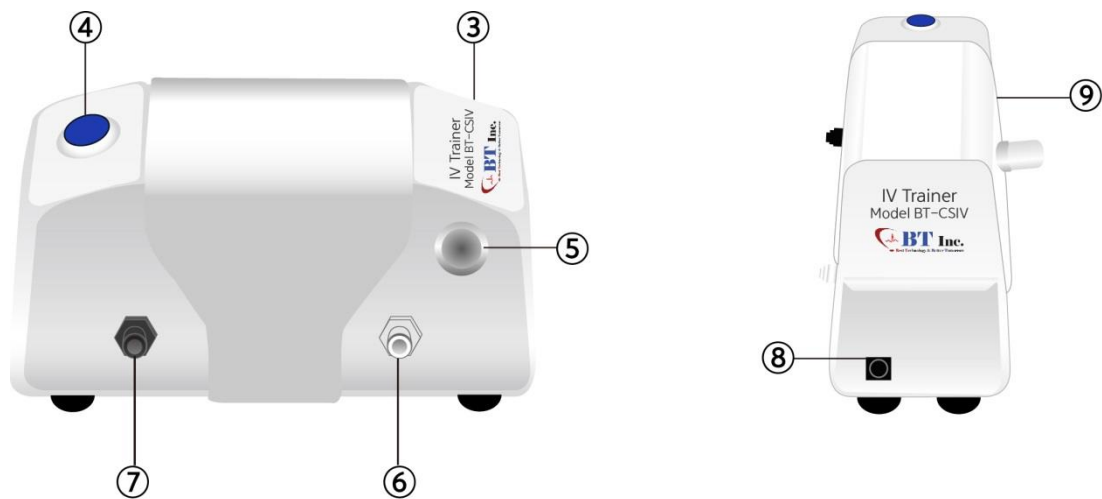

③ Blood circulation controller

④ Timer switch

⑤ Rapid blood circulation switch

⑥ Blood IN connector

⑦ Blood OUT connector

⑧ Power supply connector

⑨ Arm mount adaptor

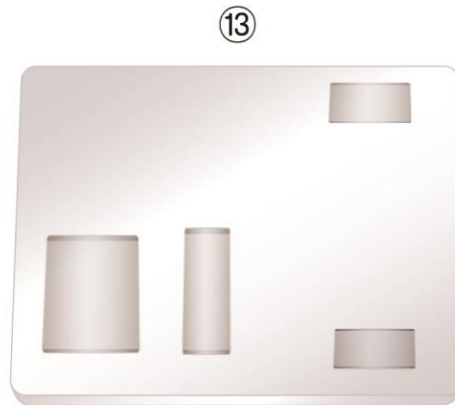
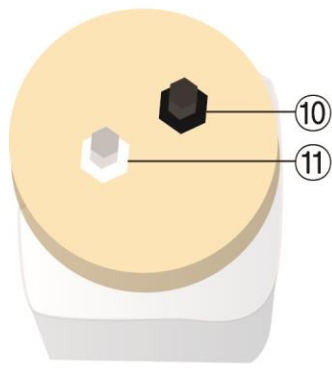

- ⑩ Plastic bottle IN connector
- ⑪ Plastic bottle OUT connector
- ⑫ Connection tube
- ⑬ Mount

5. Installation

(1) Please arrange the product as the figure below.

- Either Adapter or Battery can be used as the power supply.
- Drop a few drops of simulated blood in a plastic bottle with some water and shake it.

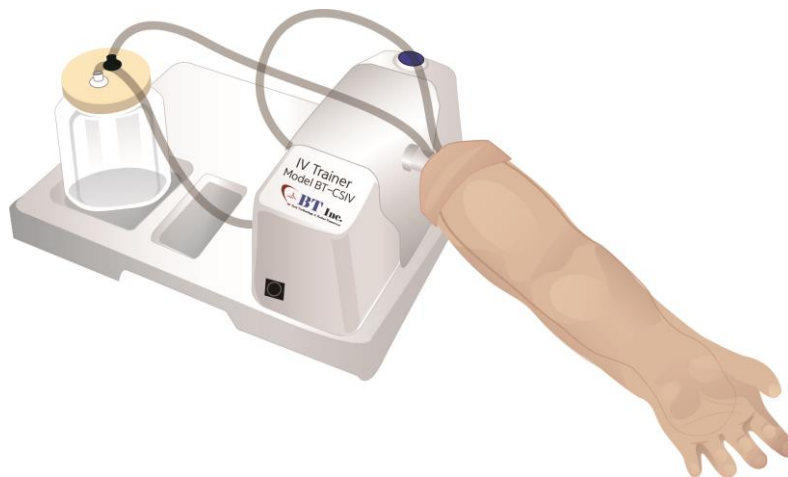

(2) Connect the silicon tube as below.



6. User Manual

- (1) As described in "5. Installation" , connect the power supply and connection tube.
- (2) If you connect the power supply properly, You can hear a short buzzer sound.
- (3) Press the Rapid Blood Circulation Switch to fill the blood vessel of Skin pad with simulated blood.

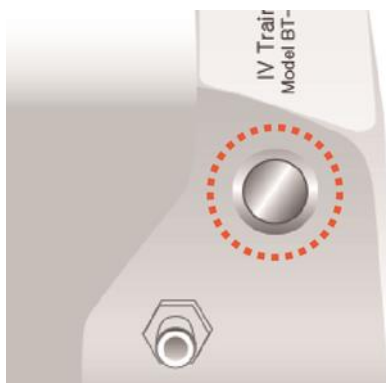

- (4) The purpose of Rapid Blood Circulation Switch is to fill simulated blood into the empty Skin-pad rapidly.
- (5) After you press the Timer Switch once, you can hear one buzzer sound in about two second. Then the LED lamp turns on and blood flows for 5 minutes.
- (6) When you press the Timer Switch more than once, you can hear buzzer sounds as shown in the chart below. Then, blood will flow for several minutes as shown below.
- (7) When you press the Timer Switch 7 times, you can hear three buzzer sounds. Then blood circulation will stop.

No. of counts for pressing timer switch	Total Operating time(min)	Buzzer Sound	Remark
1	5	1	beep
2	10	2	beep-beep
3	15	3	beep-beep-beep
4	20	4	beep-beep-beep-beep
5	25	5	beep-beep-beep-beep-beep
6	30	6	beep-beep-beep-beep-beep-beep
7	Automatic Stop	3	beep-beep-----beep

(8) When you press the Timer Switch for 3 seconds, blood circulation will stop automatically.



(9) After terminating the operation, you can hear the three buzzer sounds. (beep – beep --- beep)

(10) If you want to restart, just press the Timer Switch again.

(11) After finishing the practice, please keep the product as described in **“Chapter 7. Cleaning and Storage”**.

7. Cleaning and Storage

- (1) After finishing the practice, you need to disconnect the white connector from the Plastic Bottle and then press the Rapid Blood Circulation Switch to remove blood in the tube.
- (2) Fill the bottle with clean water after expelling simulated blood.
(You can reuse the simulated blood if you keep the blood in an empty container)
- (3) Reconnect the white connector to the Plastic bottle.
- (4) Press the Rapid Blood Circulation Switch in order to circulate the clean water to clean up the tube.
- (5) Disconnect the white connector from the Plastic Bottle and then press the Rapid Blood Circulation Switch to remove clean water in the tube just as "(1)".
- (6) After pouring the water out of the bottle, disconnect the connection tubes.
- (7) If water leaks out from the end of connector, remove water with the tissue paper or soft cloth.
- (8) Please keep the product carefully in the Storage case.

