

BT-CSIV-S

# Intravenous Injection Training Model

## USER'S GUIDE

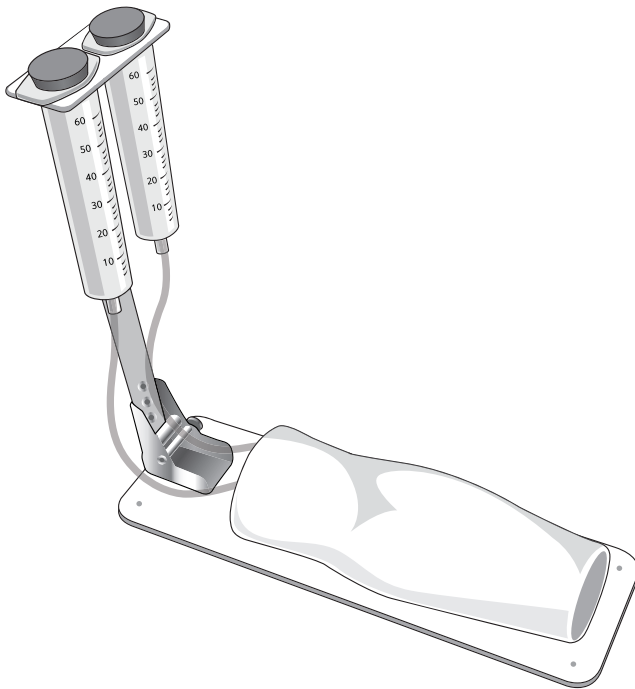

# Product Information

Product Name	Intravenous Injection Training Model
Model Name	BT-CSIV-S
Manufacturer	BT Inc.
Country of Origin	South Korea

# Customer Service

Web-site	<a href="http://www.btinc.co.kr">www.btinc.co.kr</a>
Address	Headquarter : A-313 Samsung Techno-valley, 140, Tongil-ro, Deogyang-gu, Goyang-si, Gyeonggi-do, 10594, South Korea Sales : Busan Building 5F, 27, Jeonpo-daero 92beon-gil, Nam-gu, Busan 48404, South Korea
Contacts	Headquarter : +82-2-2038-2903 Sales : +82-51-903-1144
E-mail	<a href="mailto:bt@btinc.co.kr">bt@btinc.co.kr</a>

# Cautions

Please read it carefully to ensure correct usage and user's safety through understanding of the product.

- ① Do not use the product for other purposes described in the manual.
- ② If you disassemble or modify the product without any permission by BT Inc, you cannot get the warranty. Also, making imitated or altered products for commercial purposes are prohibited by law.
- ③ Keep the product away from water and moisture.
- ④ Do not keep the product near hot or cold environments as possible. Deterioration of product or internal damage may occur by the extreme weather conditions.
- ⑤ BT Inc. can change or adjust the product specification without any notice in order to improve the product.

# Components

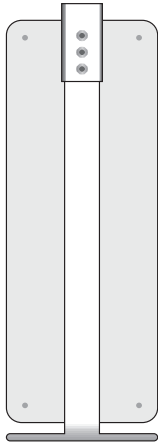

Stand

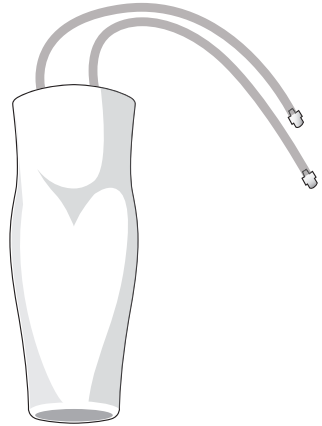

Arm Manikin

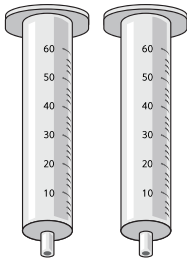

Blood Supply Bottle

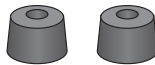

Rubber stoppers



Simulated Blood

\* Arm : 0.2kg (230×90×65mm), Stand : 0.5kg (350×100×50mm)

# Installation

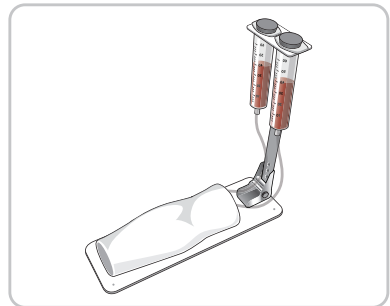
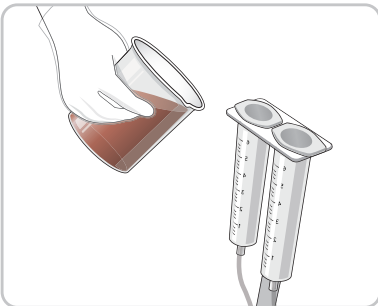
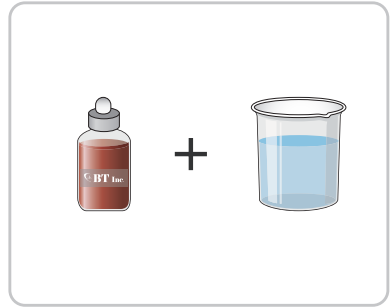
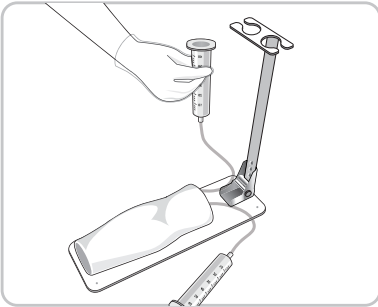
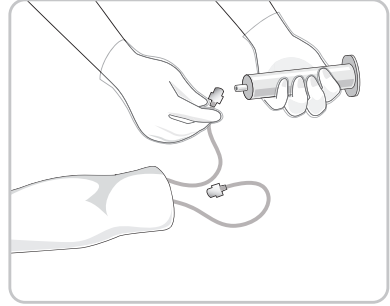
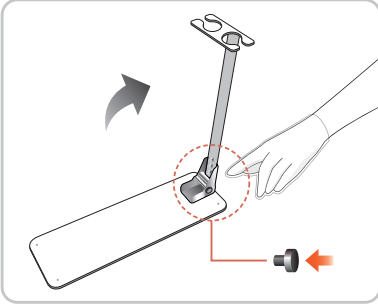

# Maintenance

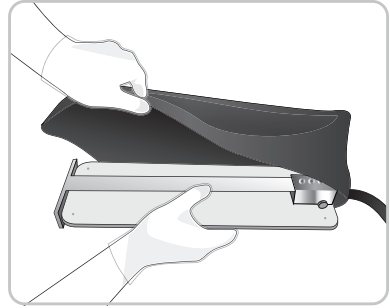
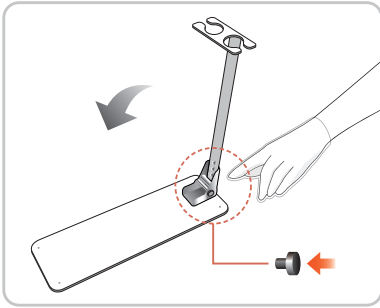
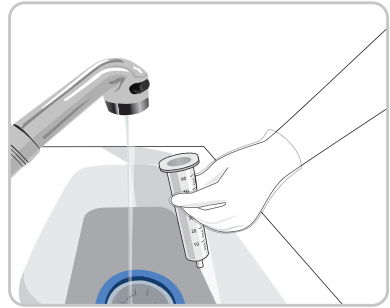
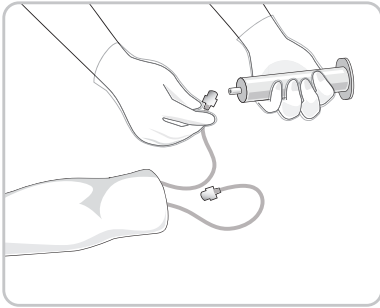
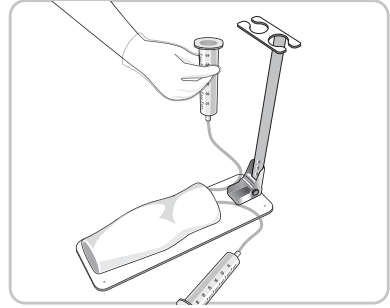
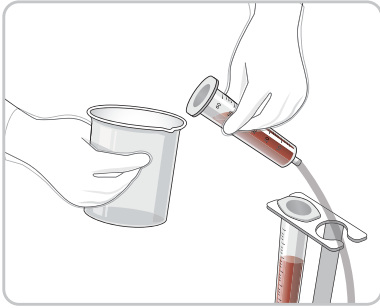

BT-CSIV-S

# Intravenous Injection Training Model

A-313, Samsung Techno-valley, 140, Tongil-ro,  
Deogyang-gu, Goyang-si, Gyeonggi-do, 10594, Republic of Korea  
Homepage: [www.btinc.co.kr](http://www.btinc.co.kr) / E-mail: [bt@btinc.co.kr](mailto:bt@btinc.co.kr)  
Tel: +82-2-2038-2903, +82-51-903-1144 / Fax: +82 303-3130-0607

Copyright(c) BT Inc. All rights reserved.